

COMPONENTS FOR CONVEYORS

# magris



MAKES MOVING

**CONSTRUKTOR**<sup>TM</sup>

[www.construktor.com](http://www.construktor.com)

**STALOWE ŁAŃCUCHY PŁYTKOWE**

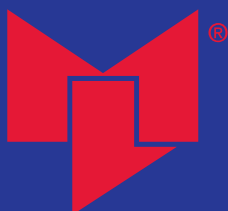

# magris



magris prides itself on nearly fifty years of experience as one of the leader manufacturer of hinged slat chains and accessories in steel/stainless steel and thermoplastic resin for conveyor belts used in packaging, bottling, glass, pharmaceutical, chemical, food, mechanical industry, etc.

Nowadays, the magris team continues this activity exporting all over the world through a qualified network of agents and distributors and also a short delivery time is granted through a warehouse containing large quantities of the most required items (up to 1.000 metres each chain type); non-stock and tailor-made orders can be supplied in short term.

The choice of chain materials has been specifically studied by skilled specialists and developed in cooperation with the main stainless steel and thermoplastic manufacturers, as far as the final performance is granted by chain tests which strictly conform to international regulations, e.g. careful inspections carried out during all the stages of production, whose quality is constantly supported by technological researches.

magris production range for conveyor belts includes:

- Steel/stainless steel hinged slat chains;
- Thermoplastic hinged slat chains;
- Sprockets and idlers, curves, guide rails profiles, accessories and components in thermoplastic resin.



<b>contents</b>	<b>2</b>	Materials	<b>20</b>	Sideflexing hinged slat chains Flex RXMS - Hard Inox
	<b>4</b>	Chain sizing	<b>21</b>	Sideflexing hinged slat chains Flex RXM - Inox 18/8
	<b>10</b>	Straight running chains - Single hinge Super - Hard Inox	<b>21</b>	Sideflexing hinged slat chains Flex RXM - Inox 316
	<b>11</b>	Straight running chains - Single hinge Superspeed - HQ Inox	<b>21</b>	Sideflexing hinged slat chains Flex RXMA - Carbon Steel
	<b>11</b>	Straight running chains - Single hinge Wear-Proof - HQ Inox	<b>22</b>	Sideflexing hinged slat chains Flex FMC - Inox
	<b>11</b>	Straight running chains - Single hinge Standard - Inox	<b>22</b>	Sideflexing hinged slat chains Flex FMS - Hard Inox
	<b>12</b>	Straight running chains - Single hinge Special - Inox	<b>22</b>	Sideflexing hinged slat chains Flex FMD - HQ Inox
	<b>12</b>	Straight running chains - Single hinge 316 - Inox 316	<b>22</b>	Sideflexing hinged slat chains Flex FM - Inox 18/8
	<b>12</b>	Straight running chains - Single hinge Stella D - Inox 18/8	<b>23</b>	Sideflexing hinged slat chains Flex FMS2 R=190 mm - Hard Inox
	<b>13</b>	Straight running chains - Single hinge Accate C - Carbon steel	<b>23</b>	Sideflexing hinged slat chains Flex FM2 R=190 mm - Inox 18/8
	<b>13</b>	Straight running chains - Single hinge Accate - Carbon steel	<b>23</b>	Sideflexing hinged slat chains Flex FMA2 R=190 mm - Carbon steel
	<b>14</b>	Mignon straight running chains - Single hinge Standard - Inox	<b>24</b>	Sideflexing hinged slat chains for magnetic systems New Flex Mag - Inox
	<b>14</b>	Mignon straight running chains - Single hinge Stella D - Inox 18/8	<b>24</b>	Sideflexing hinged slat chains for magnetic systems New Flex Mag - Hard Inox
	<b>14</b>	Mignon straight running chains - Single hinge Super - Hard Inox	<b>24</b>	Sideflexing hinged slat chains for magnetic systems New Flex Mag D - HQ Inox
	<b>15</b>	Straight running chains - Single hinge 1 Inch Super - Hard Inox	<b>25</b>	Sideflexing chains for magnetic systems - Reinforced hinge New Flex Mag - Hard Inox
	<b>16</b>	Straight running chains - Single reinforced hinge Super - Hard Inox	<b>26</b>	Straight running chains with rubber inserts for inclined conveyors Super G/DHG - Hard Inox
	<b>17</b>	Straight running chains - Double hinge Standard - Inox	<b>27</b>	Sideflexing hinged slat chains with rubber inserts for inclined conveyors Flex RXMS G/New Flex G Mag - Hard Inox
	<b>17</b>	Straight running chains - Double hinge Super - Hard Inox	<b>28</b>	Block body machined steel sprockets
	<b>17</b>	Straight running chains - Double hinge Stella D - Inox 18/8	<b>29</b>	1864 Straight running plate top chains
	<b>18</b>	Straight running chains - Double hinge Accate - Carbon Steel	<b>30</b>	1874 Sideflexing plate top chains
	<b>19</b>	Straight running chains - Double reinforced hinge Stella D - Inox 18/8	<b>31</b>	Steel corrosion resistance table
	<b>20</b>	Sideflexing hinged slat chains Flex RXMC - Inox	<b>32</b>	Credits

## SLATS

### HARD INOX

Special work hardened, chrome-nickel, highly wear corrosion resistant stainless steel. It offers excellent mechanical characteristics and exceptional sliding properties, thanks to a very low surface roughness. It is particularly suitable for the critical points of bottling lines. Material used for the following chain models: Super, Flex RXMS, Flex FMS, Flex FMS2, New Flex Mag, Super G, Flex RXMS G and New Flex Mag G. Minimum temperatures: - 40 °C  
Maximum temperatures: + 260 °C (dry env.), + 120 °C (wet env.)

### INOX

Ferritic, AISI 430 stainless steel, work hardened by cold-rolling, with good corrosion resistance. It has an excellent surface finishing with a low roughness, that is a very important quality for the sliding of conveyed products. It is the preferred choice for standard bottling industry applications. Material used for the following chain models: Special, Standard and Flex RXMC. Minimum temperatures: - 40 °C  
Maximum temperatures: + 260 °C (dry env.), + 120 °C (wet env.)

### HQ INOX (high quality)

Special, new, chrome-nickel (W.1.4589) stainless steel, work hardened. It has been developed in cooperation with a major stainless steel manufacturer for very special applications such as pressureless combiners/inliners. Cold rolled to extremely high quality standards, this material is the right answer to the most sophisticated needs. Its exceptional surface finishing and flatness together with a very high working load and wear resistance are unique features. Material used for the following chain models: Superspeed, Wear Proof, Flex FMD and New Flex Mag D. Minimum temperatures: - 40 °C  
Maximum temperatures: + 260 °C (dry env.), + 120 °C (wet env.)

### INOX 18/8

Austenitic, non-magnetic AISI 304 stainless steel (18% Chrome - 8% Nickel), work hardened for high resistance. It provides excellent resistance to chemical agents and corrosion, and offers excellent mechanical and duration characteristics. It is mainly used in the preservation and bottling industry. Approved by Food and Drug Administration (FDA), American government institute for the direct contact with foodstuff. Material used for the following chain models: Stella D, Flex RXM, Flex FM and Flex FM2. Minimum temperatures: - 40 °C  
Maximum temperatures: + 400 °C (dry env.), + 120 °C (wet env.)

### INOX 316

Austenitic AISI 316L stainless steel (18% Chrome - 14% Nickel - 3% Molybdenum). It is ideal with chemical agents and strong acids. Material used for the following chain models: 316 and Flex RXM 316. Minimum temperatures: - 40 °C  
Maximum temperatures: + 400 °C (dry env.), + 120 °C (wet env.)

### CARBON STEEL

Heat-treated carbon steel with a surface and core hardness of 43 HRC. It is especially suitable for high working loads and it is highly resistant to wear. It is recommended for the glass, ceramic and general product conveying industry. In case of difficult applications, such as with abrasive dust, the carbon steel can be, upon request, case-hardened, thus reaching a surface hardness of 55 HRC and a core hardness of 40 HRC. Material used for the following chain models: Accate, Flex RXMA and Flex FMA2. Minimum temperatures: - 40 °C  
Maximum temperatures: + 180 °C (dry env.), + 120 °C (wet env.)

## PINS

### STANDARD PINS

The following chain models :  
Special, Standard, Super, Super G,  
Flex RXMC, Flex RXMS, Flex RXMS G,  
Flex FMS, Flex FMS2 and New Flex  
Mag, have pins made of AISI 431  
stainless steel, magnetic and work  
hardened for high resistance.

### HB PINS

The following chain models :  
Wear Proof, Superspeed, Flex FMD  
and New Flex Mag D, have pins made  
of special martensitic stainless steel,  
magnetic and heat-treated for high  
resistance.

- Increased wear resistance
- Pins life up to 40% higher

### XHB PINS

Special hardened pins series XHB are  
available upon request.  
They offer an additional wear  
resistance combined with an higher  
corrosion strength.

- Pins life up to 100% higher

### AUSTENITIC 18/8 PINS

The following chain models:  
Stella D, Flex RXM, Flex FM, Flex FM2  
have pins made of austenitic stainless  
steel (18% Chrome - 8% Nickel), work  
hardened for high resistance.

- Excellent corrosion resistance.

### AISI 316 PINS

The following chain models:  
316 and Flex RXM 316, have pins made  
of austenitic AISI 316 stainless steel.

- Exceptional corrosion resistance.

### CASE-HARDENED CARBON STEEL PINS

The following chain models:  
Accate, Accate C, Flex RXMA, Flex  
RXMA C and Flex FMA2, have pins  
made of case-hardened carbon steel .

NB.: Upon request, all our chains can be produced with other types of stainless steel.

Every care has been taken to ensure the accuracy of the information contained in this catalogue  
but no liability can be accepted for any errors or omissions.

# chain sizing

According to the maximum allowable working load method.

Chain sizing consists of a comparison between the chain tension at headshaft, which a chain is subject to, and the maximum allowable working load of the chain itself. The following formulas allow an evaluation of the chain tension at headshaft as a function of the different load conditions.

Ft	Chain tension at headshaft (N)	$\alpha$	Bending angle (gradi)
Fo	Chain tension on return track (N)	K	Length factor table (table D)
F1, F2, . . .	Sum of all loads (N)	T	Curve factor (table D)
Wc	Chain weight (Kg/m)	f1	Friction factor between chain and wear strips (table A)
Wm	Conveyed product weight (Kg/m)	f2	Friction factor between chain and conveyed products (table A)
L	Horizontal conveyor length (m)	fp	Start up factor (table B)
L1, L2, . . .	Conveyor track length (m)	S	Slippage factor (table C)
H	Vertical conveyor elevation (m)	9.81	Gravity acceleration (m/s <sup>2</sup> )
Ls	Conveyor length of the section where accumulation occurs (m)		
L1s, L2s, . . .	Conveyor length of the section where accumulation occurs (m)		
R	Curve radius (m)		

## SYMBOLS

Chain materials: carbon steel and stainless steel

A	f <sub>1</sub>		f <sub>2</sub>		
	Friction factor between chain and wear strips		Friction factor between chain and conveyed products		
Lubrication used	Steel	High density polyethylene, nylon	Cardboard plastic	Metal	Glass ceramic
Dry*	0,50	0,20	0,30	0,45	0,45
Water	0,40	0,15	0,25	0,40	0,40
Soapy water	0,20	0,12	0,15	0,20	0,25
Oil	0,20	0,08	-	0,15	0,20

B	Start up factor
Start ups per hour	f <sub>p</sub>
0	1,0
5	1,4
10	1,7
15	1,8
20	1,9
25	2,0

\* Although the theoretical calculation is carried out in dry running conditions, we recommend the use of lubricated chains in order to avoid chain blocking and friction.

C	Slippage factor
Slippage time percentage	S
0	0
10	0,5
20	0,7
30	0,8
40	0,9
50 >	1,0

D	K	T			
		Curve factor			
		Stainless steel chain			
Bending angle	Length factor	Steel wear strips		High density polyethylene and nylon wear strips	
degrees $\alpha$		Dry*	Lubricated	Dry*	Lubricated
15	0,25	1,20	1,05	1,10	1,05
30	0,52	1,30	1,10	1,20	1,10
45	0,79	1,40	1,20	1,30	1,20
60	1,05	1,60	1,30	1,50	1,25
90	1,57	2,00	1,50	1,80	1,35
120	2,09	2,50	1,70	2,20	1,50
150	2,62	3,10	1,90	2,70	1,75
180	3,14	3,50	2,10	3,00	1,90



In this case the calculation of the chain tension at headshaft is carried out as the sum of successive loads (draw. 1):

$$L_2 = K(\alpha_2) \times R_2$$

$$L_4 = K(\alpha_4) \times R_4$$

### 1 - Return run

the evaluation of the chain tension in the return run is carried out by starting at the driven sprockets following the movement of the chain itself up to the return sprocket (draw 2):

$$\text{Track FE } F_5 = W_c \times L_5 \times f_1$$

$$\text{Track FD } F_4 = [F_5 + W_c \times L_4 \times f_1] \times T(\alpha_4)$$

$$\text{Track FC } F_3 = F_4 + W_c \times L_3 \times f_1$$

$$\text{Track FB } F_2 = [F_3 + W_c \times L_2 \times f_1] \times T(\alpha_2)$$

$$\text{Track FA } F_1 = F_2 + W_c \times L_1 \times f_1$$

$$F_0 = F_1 \times f_p \times 9,81$$

Written in a more explicit manner:

$$F_0 = \{ [(L_5 + L_4) \times W_c \times f_1 \times T(\alpha_4) + (L_3 + L_2) \times W_c \times f_1] \times T(\alpha_2) + L_1 \times W_c \times f_1 \} \times f_p \times 9,81$$

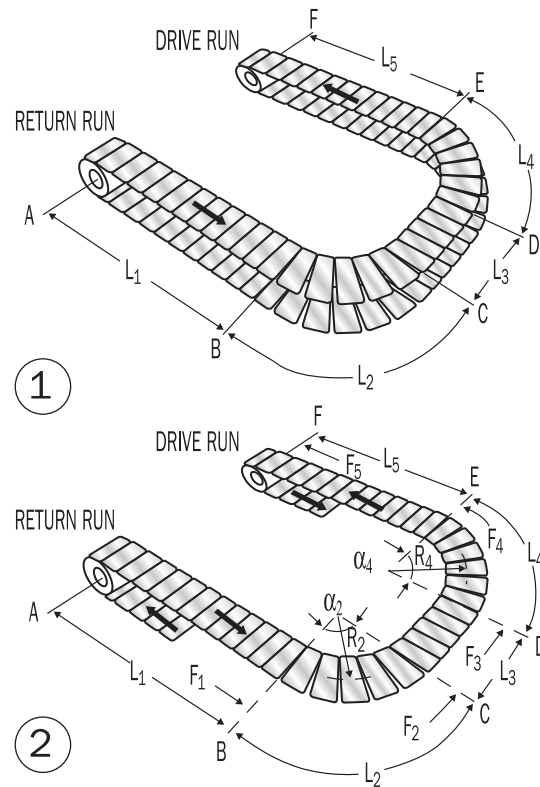

## CONVEYORS WITH SIDEFLEXING CHAINS

### 2 - Drive run

- Chain tension at headshaft without accumulation •

The evaluation of the chain tension in the conveying run is carried out by starting from the return sprocket following the movement of the chain itself up to the drive sprocket (draw. 3):

$$\text{Track AB } F_1 = F_0 + (W_c + W_m) \times L_1 \times f_1 + f_p \times 9,81$$

$$\text{Track AC } F_2 = [F_1 + (W_c + W_m) \times L_2 \times f_1 + f_p \times 9,81] \times T(\alpha_2)$$

$$\text{Track AD } F_3 = F_2 + (W_c + W_m) \times L_3 \times f_1 + f_p \times 9,81$$

$$\text{Track AE } F_4 = [F_3 + (W_c + W_m) \times L_4 \times f_1 + f_p \times 9,81] \times T(\alpha_4)$$

$$\text{Track AF } F_5 = F_4 + (W_c + W_m) \times L_5 \times f_1 + f_p \times 9,81$$

- Chain tension at headshaft with accumulation •

The component of the chain tension at headshaft due to the accumulation of material conveyed is evaluated by starting from the return sprocket towards the drive sprocket, for the only track involved by the accumulation (draw. 3).

In this case the total chain tension at headshaft is given by the sum of the component without accumulation plus the one due to the accumulation of the material:

$$\text{Track AB } F_1 = F_0 + [(W_c + W_m) \times L_1 \times f_1 + f_p + L_1s \times W_m \times f_2 \times S] \times 9,81$$

$$\text{Track AC } F_2 = \{ F_1 + [(W_c + W_m) \times L_2 \times f_1 + f_p + L_2s \times W_m \times f_2 \times S] \times 9,81 \} \times T(\alpha_2)$$

$$\text{Track AD } F_3 = F_2 + [(W_c + W_m) \times L_3 \times f_1 + f_p + L_3s \times W_m \times f_2 \times S] \times 9,81$$

$$\text{Track AE } F_4 = \{ F_3 + [(W_c + W_m) \times L_4 \times f_1 + f_p + L_4s \times W_m \times f_2 \times S] \times 9,81 \} \times T(\alpha_4)$$

$$\text{Track AF } F_5 = F_4 + [(W_c + W_m) \times L_5 \times f_1 + f_p + L_5s \times W_m \times f_2 \times S] \times 9,81$$

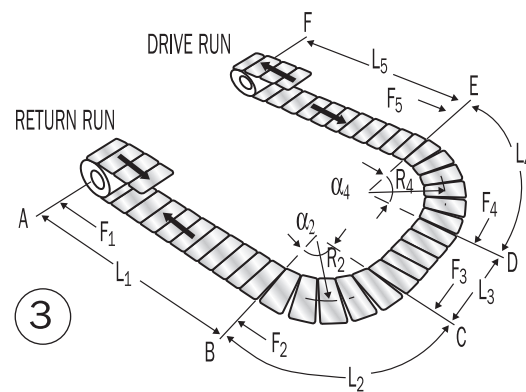

## CONVEYORS WITH STRAIGHT RUNNING CHAINS

### Horizontal conveyor

Without accumulation

$$F_t = (2W_c + W_m) \times L \times f_1 \times f_p \times 9,81$$

With accumulation

$$F_t = [(2W_c + W_m) \times L \times f_1 \times f_p + L_s \times W_m \times f_2 \times S] \times 9,81$$

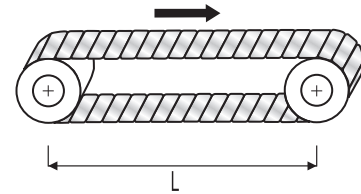

### Inclined conveyor

Without accumulation

$$F_t = [(2W_c + W_m) \times L \times f_1 \times f_p + (W_c + W_m) \times H] \times 9,81$$

With accumulation

$$F_t = [(2W_c + W_m) \times L \times f_1 \times f_p + (W_c + W_m) \times H + L_s \times W_m \times f_2 \times S] \times 9,81$$

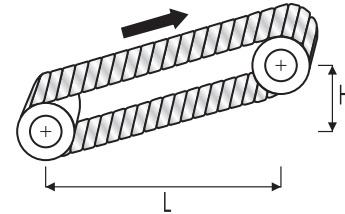

## SYMBOLS FOR STRAIGHT RUNNING CHAINS

1864. . . .	Plate top chain
7.24.000	Double reinforced hinged slat chain - Stella D Mod.
7.94.000	Double hinged slat chain - Accate Mod.
7.14.000	Double hinged slat chain - Stella D Mod.
S.7.04.000	Double hinged slat chain - Super Mod.
SG.7.04.000	Double hinged slat chain - Super DHG Mod.
7.04.000	Double hinged slat chain - Standard Mod.
C.7.90.000	Single hinged slat chain - Accate C Mod.
7.90.000	Single hinged slat chain - Accate Mod.
7.25.000	Single hinged slat chain - 316 Mod.
7.10.000	Single hinged slat chain - Stella D Mod.
DX.7.00.000	Single hinged slat chain - Superspeed Mod.
D.7.00.000	Single hinged slat chain - Wear Proof Mod.
S.7.00.175	Single reinforced hinged slat chain - Super Mod.
S.7.00.000	Single hinged slat chain - Super Mod.
SG.7.00.175	Single reinforced hinged slat chain - Super G Mod.
SG.7.00.000	Single hinged slat chain - Super G Mod.
7.00.000	Single hinged slat chain - Standard Mod.
H.7.00.000	Single hinged slat chain - Special Mod.
S.9.00.000	Single hinged slat chain - 1 Inch Mod.
7.10.010	Mignon hinged slat chain - Stella D Mod.
7.00.010	Mignon hinged slat chain - Standard Mod.
8.25.000	Mignon hinged slat chain - Super Mod.
SG.8.25.000	Mignon hinged slat chain - Super G Mod.



## SYMBOLS FOR SIDEFLEXING CHAINS

1874. . . .	Plate top chain
C.8.93.000	Hinged slat chain - Flex RXMA C Mod.
8.99.000	Hinged slat chain - Flex FMA2 Mod.
8.93.000	Hinged slat chain - Flex RXMA Mod.
8.33.000	Hinged slat chain - Flex RXM 316 Mod.
8.13.000	Hinged slat chain - Flex RXM Mod.
8.16.000	Hinged slat chain - Flex FM Mod.
8.19.000	Hinged slat chain - Flex FM2 Mod.
D.8.26.000	Hinged slat chain - Flex FMD Mod.
S.8.23.000	Hinged slat chain - Flex RXMS Mod.
SG.8.23.000	Hinged slat chain - Flex RXMS G Mod.
S.8.26.000	Hinged slat chain - Flex FMS Mod.
S.8.29.000	Hinged slat chain - Flex FMS2 Mod.
8.26.000	Hinged slat chain - Flex FMC Mod.
8.23.000	Hinged slat chain - Flex RXMC Mod.
D.7.08.000	Hinged slat chain - New Flex Mag D Mod.
S.7.08.175	Reinforced hinged slat chain - New Flex Mag Mod.
S.7.08.000	Hinged slat chain - New Flex Mag Mod.
7.08.000	Hinged slat chain - New Flex Mag C Mod.
SG.7.08.175	Reinforced hinged slat chain - New Flex Mag G Mod.
SG.7.08.000	Hinged slat chain - New Flex Mag G Mod.

Calculation of Power (P) 
$$P = \frac{F_t \times v}{6 \times 10^4}$$

where: (P) = Power (kW) ,  $F_t$  = Chain tension at headshaft on the chain (N), v = Speed (m/min)

## CHAIN SELECTION

Having evaluated the chain tension at headshaft which the chain is subject to, and calculated the speed/length of the conveyor ratio, the two values are stated in figure 4. The chain suitable for the use in question is the one whose curve is immediately above the intersection of the two values.

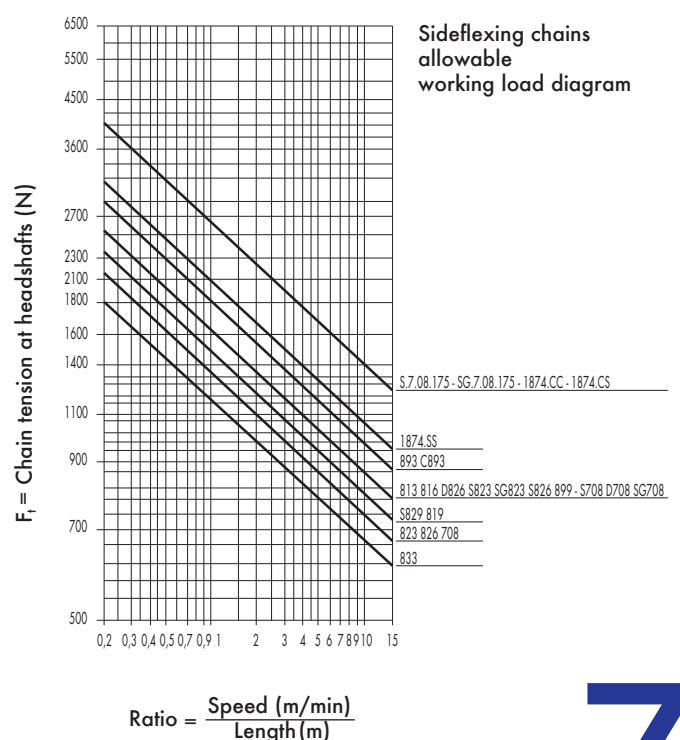
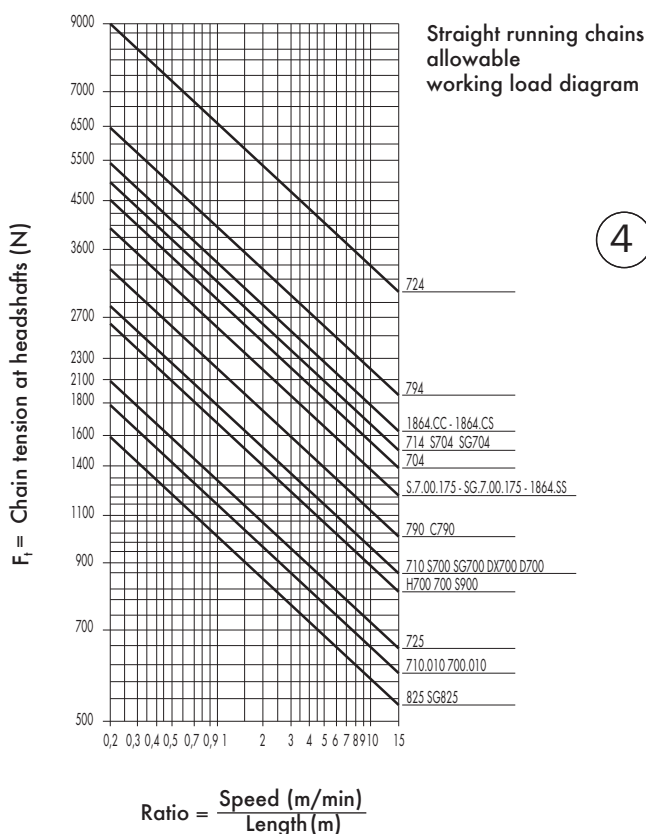

## EXAMPLE

The 7.10.040 chain, dry-operating, conveys glass wine bottles. The bottles weigh 1,5 Kg each and they are placed on the chain at 20 cm intervals (5 bottles per metre). The chain stops and restarts 10 times per hour. There is accumulation of the 20% operating time and on a length of 8 metres.

- Aims:
- Chain checking;
  - Calculation of the power needed by the shaft.
- Start up data:
- Speed ( $v$ ) = 45 m/min.
  - Start up factor ( $f_p$ ) = 1,7 (table B)
  - Slippage time percentage = 20%
  - Slippage factor ( $S$ ) = 0,7 (table C)
  - Length with accumulation ( $L_s$ ) = 8 m
  - Friction factor ( $f_2$ ) = 0,45 (table A: chain-glass bottle)
  - Conveyor length ( $L$ ) = 12 m
  - Chain weight ( $W_c$ ) = 2,6 Kg/m
  - Conveyed product weight ( $W_m$ ) = 7,5 Kg/m
  - Friction factor ( $f_1$ ) = 0,20 (table A: chain-polyethylene wear strip)

Calculation of the chain tension at Headshaft ( $F_t$ )

$$\begin{aligned} F_t &= [(2W_c + W_m) \times L \times f_1 \times f_p + L_s \times W_m \times f_2 \times S] \times 9,81 \\ &= [(2 \times 2,6 + 7,5) \times 12 \times 0,20 \times 1,7 + 8 \times 7,5 \times 0,45 \times 0,7] \times 9,81 \\ &= 693,72 \text{ N} \end{aligned}$$

Calculation of the Speed/Length ratio ( $v/L$ )

$$v/L = 45/12 = 3,75 \text{ m/min/m}$$

The "allowable working load" diagram shows that the maximum chain tension at headshaft available for that chain and for that speed ratio is 1300 N. The selected chain is therefore suitable for our purpose.

Calculation of Power ( $P$ )

$$P = \frac{F_t \times v}{6 \times 10^4} = \frac{693,72 \times 45}{6 \times 10^4} = 0,520 \text{ kW}$$



# Straight running chains - Single hinge

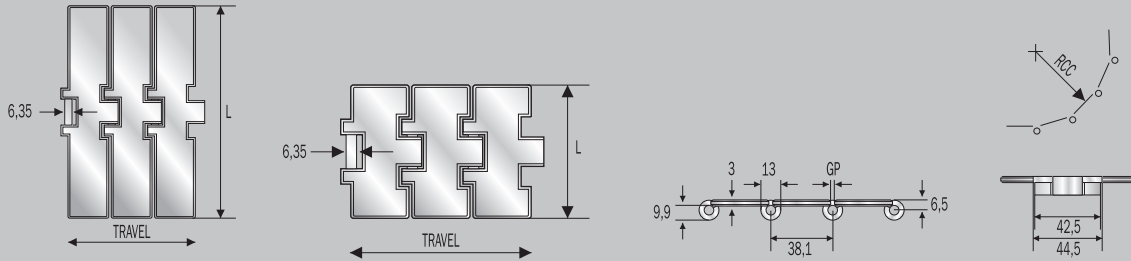
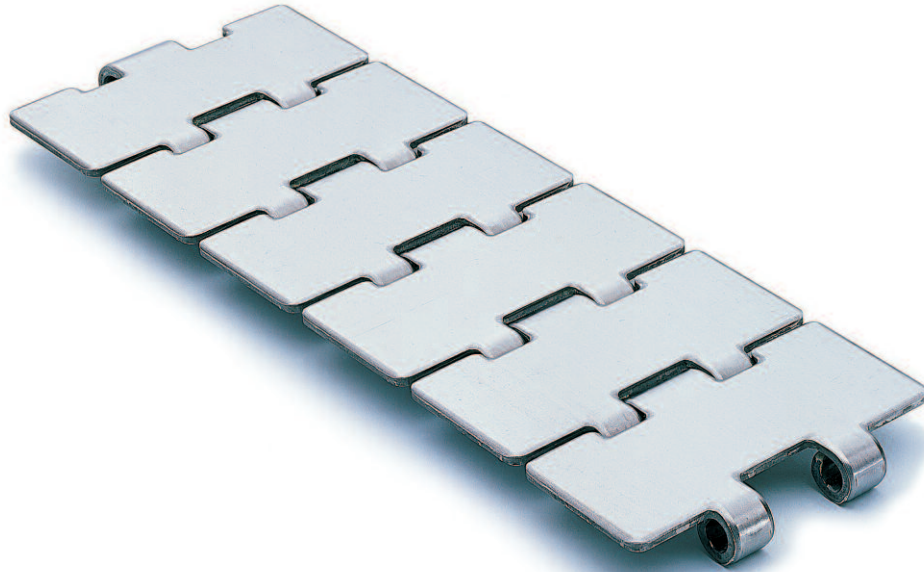

HB OR XHB PINS  
UPON REQUEST

## SUPER - HARD INOX

- Special, chrome-nickel, stainless steel slats, work hardened for high resistance, with shiny surface having a roughness of  $R_a \leq 0,3$  micron.
- AISI 431 stainless steel pins, magnetic and work hardened for high resistance.

### PRODUCT CODES

SSHR 812 K213*	internal code S.7.00.013
SSHR 812 K250	internal code S.7.00.020
SSHR 812 K325	internal code S.7.00.040
SSHR 812 K335	internal code S.7.00.050
SSHR 812 K500*	internal code S.7.00.090

### CHARACTERISTICS

	Slat width (mm/ ")	Hardness (HRC)	GP (mm)	RCC (mm)	Weight kg/m	
SSHR 812 K213*	54.1	-	30	2.8	75	2.10
SSHR 812 K250	63.5	2 $\frac{1}{2}$	30	2.8	75	2.20
SSHR 812 K325	82.5	3 $\frac{1}{4}$	30	2.8	75	2.60
SSHR 812 K335	85.0	-	30	2.8	75	2.68
SSHR 812 K500*	127.0	5	30	2.8	75	3.50

REDUCED PLATE GAP (1.6)

### PRODUCT CODES

SSH 812 K225	internal code S.7.00.015
SSH 812 K250	internal code S.7.00.021
SSH 812 K263	internal code S.7.00.025
SSH 812 K275	internal code S.7.00.200
SSH 812 K300	internal code S.7.00.031
SSH 812 K325	internal code S.7.00.041
SSH 812 K330	internal code S.7.00.042
SSH 812 K350	internal code S.7.00.061
SSH 812 K400	internal code S.7.00.070
SSH 812 K450	internal code S.7.00.080
SSH 812 K600	internal code S.7.00.100
SSH 812 K750	internal code S.7.00.110

### CHARACTERISTICS

	Slat width (mm/ ")	Hardness (HRC)	GP (mm)	RCC (mm)	Weight kg/m	
SSH 812 K225	57.1	2 $\frac{1}{4}$	30	1.6	150	2.18
SSH 812 K250	63.5	2 $\frac{1}{2}$	30	1.6	150	2.25
SSH 812 K263	66.7	2 $\frac{5}{8}$	30	1.6	150	2.33
SSH 812 K275	69.9	2 $\frac{3}{4}$	30	1.6	150	2.35
SSH 812 K300	76.2	3	30	1.6	150	2.50
SSH 812 K325	82.5	3 $\frac{1}{4}$	30	1.6	150	2.65
SSH 812 K330	83.8	3 $\frac{19}{64}$	30	1.6	150	2.70
SSH 812 K350	88.9	3 $\frac{1}{2}$	30	1.6	150	2.75
SSH 812 K400	101.6	4	30	1.6	150	3.00
SSH 812 K450	114.3	4 $\frac{1}{2}$	30	1.6	150	3.30
SSH 812 K600	152.4	6	30	1.6	150	4.20
SSH 812 K750	190.5	7 $\frac{1}{2}$	30	1.6	150	5.10

\* Size produced only upon request - delivery conditions and terms to be agreed. Standard shipping lengths: 80 pitches = 10 feet = 3,048 metres.

# SUPERSPEED - HQ INOX

< XHB PINS  
UPON REQUEST

- Special, new stainless steel, chrome-nickel (W.1.4589) slats, work hardened for high resistance with very little roughness, Ra ≤ 0.18 micron.
  - Special martensitic stainless steel pins HB series, magnetic and heat-treated for high resistance.
- The chain is produced with a special profile: thanks to its perfect levelness and shiny surface, it is particularly suitable for pressureless combiners/inliners and for high speed systems.

REDUCED PLATE GAP (1.6)

## PRODUCT CODES

SSX 812 K325	internal code DX.7.00.041
SSX 812 K330	internal code DX.7.00.042

## CHARACTERISTICS

	Slat width (mm/ ")	Hardness (HRC)	GP (mm)	RCC (mm)	Weight kg/m
SSX 812 K325	82.5 3 <sub>1/4</sub>	30	1.6	150	2.60
SSX 812 K330	83.8 3 <sub>19/64</sub>	30	1.6	150	2.70

Standard shipping lengths: 80 pitches = 10 feet = 3,048 metres.

# WEAR PROOF - HQ INOX

< XHB PINS  
UPON REQUEST

- Special, new stainless steel, chrome-nickel (W.1.4589) slats, work hardened for high resistance with very little surface roughness, Ra ≤ 0.2 micron.
- Special martensitic stainless steel pins HB series, magnetic and heat-treated for high resistance.

REDUCED PLATE GAP (1.6)

## PRODUCT CODES

SSHQR 812 K325	internal code D.7.00.040
----------------	--------------------------

## PRODUCT CODES

SSHQ 812 K325	internal code D.7.00.041
SSHQ 812 K330	internal code D.7.00.042

## CHARACTERISTICS

	Slat width (mm/ ")	Hardness (HRC)	GP (mm)	RCC (mm)	Weight kg/m
SSHQR 812 K325	82.5 3 <sub>1/4</sub>	30	2.8	75	2.60

Standard shipping lengths: 80 pitches = 10 feet = 3,048 metres.

## CHARACTERISTICS

	Slat width (mm/ ")	Hardness (HRC)	GP (mm)	RCC (mm)	Weight kg/m
SSHQ 812 K325	82.5 3 <sub>1/4</sub>	30	1.6	150	2.65
SSHQ 812 K330	83.8 3 <sub>19/64</sub>	30	1.6	150	2.75

# STANDARD - INOX

- Ferritic, AISI 430 stainless steel slats, work hardened, with shiny surface having low roughness.
- AISI 431 stainless steel pins, magnetic and work hardened for high resistance.

REDUCED PLATE GAP (1.6)

## PRODUCT CODES

SSR 812 K213*	internal code 7.00.013
SSR 812 K250	internal code 7.00.020
SSR 812 K325	internal code 7.00.040
SSR 812 K335	internal code 7.00.050

## PRODUCT CODES

SS 812 K225	internal code 7.00.015
SS 812 K250	internal code 7.00.021
SS 812 K263	internal code 7.00.025
SS 812 K275	internal code 7.00.200
SS 812 K300	internal code 7.00.031
SS 812 K325	internal code 7.00.041
SS 812 K330	internal code 7.00.042
SS 812 K350	internal code 7.00.061
SS 812 K400	internal code 7.00.070
SS 812 K450	internal code 7.00.080
SS 812 K600	internal code 7.00.100
SS 812 K750	internal code 7.00.110

## CHARACTERISTICS

	Slat width (mm/ ")	Hardness (HRC)	GP (mm)	RCC (mm)	Weight kg/m
SSR 812 K213*	54.1 -	20	2.8	75	2.10
SSR 812 K250	63.5 2 <sub>1/2</sub>	20	2.8	75	2.20
SSR 812 K325	82.5 3 <sub>1/4</sub>	20	2.8	75	2.60
SSR 812 K335	85.0 -	20	2.8	75	2.68

## CHARACTERISTICS

	Slat width (mm/ ")	Hardness (HRC)	GP (mm)	RCC (mm)	Weight kg/m
SS 812 K225	57.1 2 <sub>1/4</sub>	20	1.6	150	2.18
SS 812 K250	63.5 2 <sub>1/2</sub>	20	1.6	150	2.25
SS 812 K263	66.7 2 <sub>5/8</sub>	20	1.6	150	2.33
SS 812 K275	69.9 2 <sub>3/4</sub>	20	1.6	150	2.35
SS 812 K300	76.2 3	20	1.6	150	2.50
SS 812 K325	82.5 3 <sub>1/4</sub>	20	1.6	150	2.65
SS 812 K330	83.8 3 <sub>19/64</sub>	20	1.6	150	2.70
SS 812 K350	88.9 3 <sub>1/2</sub>	20	1.6	150	2.75
SS 812 K400	101.6 4	20	1.6	150	3.00
SS 812 K450	114.3 4 <sub>1/2</sub>	20	1.6	150	3.30
SS 812 K600	152.4 6	20	1.6	150	4.20
SS 812 K750	190.5 7 <sub>1/2</sub>	20	1.6	150	5.10

\* Size produced only upon request - delivery conditions and terms to be agreed. Standard shipping lengths: 80 pitches = 10 feet = 3,048 metres.



## SPECIAL - INOX

- Ferritic, AISI 430 stainless steel slats, work hardened, with shiny surface having low roughness.
- AISI 431 stainless steel pins, magnetic and work hardened for high resistance.

### PRODUCT CODES

SSR 812 K325 internal code H.7.00.040

### CHARACTERISTICS

	Slat width (mm/ ")	Hardness (HRC)	GP (mm)	RCC (mm)	Weight kg/m
SSR 812 K325	82.5 3 <sup>1</sup> / <sub>4</sub>	20	2.8	75	2.55

Standard shipping lengths: 80 pitches = 10 feet = 3,048 metres.

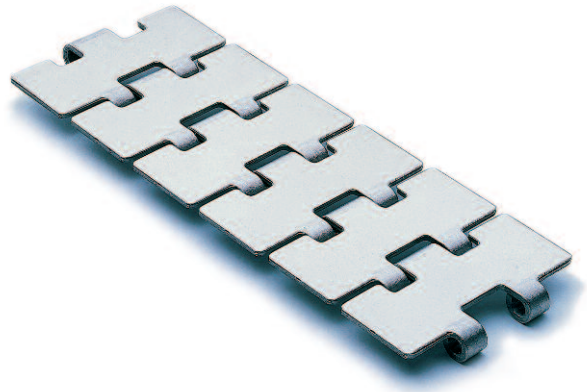

## 316 - INOX 316

- Chrome-nickel, austenitic AISI 316L stainless steel slats (18% Chrome - 14% Nickel - 3% Molybdenum).
- Austenitic AISI 316 stainless steel pins.

REDUCED PLATE GAP (1.6)

### PRODUCT CODES

SSAA 815 K325*	internal code 7.25.041
SSAA 815 K450*	internal code 7.25.080
SSAA 815 K600*	internal code 7.25.100
SSAA 815 K750*	internal code 7.25.110

### CHARACTERISTICS

	Slat width (mm/ ")	Hardness (HRC)	GP (mm)	RCC (mm)	Weight kg/m
SSAA 815 K325*	82.5 3 <sup>1</sup> / <sub>4</sub>	-	1.6	150	2.65
SSAA 815 K450*	114.3 4 <sup>1</sup> / <sub>2</sub>	-	1.6	150	3.30
SSAA 815 K600*	152.4 6	-	1.6	150	4.20
SSAA 815 K750*	190.5 7 <sup>1</sup> / <sub>2</sub>	-	1.6	150	5.10

\* Size produced only upon request - delivery conditions and terms to be agreed. Standard shipping lengths: 80 pitches = 10 feet = 3,048 metres.

## STELLA D - INOX 18/8

- Chrome-nickel, austenitic AISI 304 stainless steel slats (18% Chrome - 8% Nickel), work hardened for HR - shiny - with a roughness of Ra < 0.5 micron.
- Austenitic stainless steel pins (18% Chrome - 8% Nickel), work hardened for high resistance.

REDUCED PLATE GAP (1.6)

### PRODUCT CODES

SSAR 815 K213*	internal code 7.10.013
SSAR 815 K250	internal code 7.10.020
SSAR 815 K325	internal code 7.10.040
SSAR 815 K335*	internal code 7.10.050
SSAR 815 K500	internal code 7.10.090

### PRODUCT CODES

SSA 815 K225	internal code 7.10.015
SSA 815 K250	internal code 7.10.021
SSA 815 K263	internal code 7.10.025
SSA 815 K275	internal code 7.10.200
SSA 815 K300	internal code 7.10.031
SSA 815 K325	internal code 7.10.041
SSA 815 K350	internal code 7.10.061
SSA 815 K400	internal code 7.10.070
SSA 815 K450	internal code 7.10.080
SSA 815 K600	internal code 7.10.100
SSA 815 K750	internal code 7.10.110

### CHARACTERISTICS

	Slat width (mm/ ")	Hardness (HRC)	GP (mm)	RCC (mm)	Weight kg/m
SSAR 815 K213*	54.1 -	26	2.8	75	2.10
SSAR 815 K250	63.5 2 <sup>1</sup> / <sub>2</sub>	26	2.8	75	2.20
SSAR 815 K325	82.5 3 <sup>1</sup> / <sub>4</sub>	26	2.8	75	2.60
SSAR 815 K335*	85.0 -	26	2.8	75	2.68
SSAR 815 K500	127.0 5	26	2.8	75	3.50

### CHARACTERISTICS

	Slat width (mm/ ")	Hardness (HRC)	GP (mm)	RCC (mm)	Weight kg/m
SSA 815 K225	57.1 2 <sup>1</sup> / <sub>4</sub>	26	1.6	150	2.18
SSA 815 K250	63.5 2 <sup>1</sup> / <sub>2</sub>	26	1.6	150	2.25
SSA 815 K263	66.7 2 <sup>5</sup> / <sub>8</sub>	26	1.6	150	2.33
SSA 815 K275	69.9 2 <sup>3</sup> / <sub>4</sub>	26	1.6	150	2.35
SSA 815 K300	76.2 3	26	1.6	150	2.50
SSA 815 K325	82.5 3 <sup>1</sup> / <sub>4</sub>	26	1.6	150	2.65
SSA 815 K350	88.9 3 <sup>1</sup> / <sub>2</sub>	26	1.6	150	2.75
SSA 815 K400	101.6 4	26	1.6	150	3.00
SSA 815 K450	114.3 4 <sup>1</sup> / <sub>2</sub>	26	1.6	150	3.30
SSA 815 K600	152.4 6	26	1.6	150	4.20
SSA 815 K750	190.5 7 <sup>1</sup> / <sub>2</sub>	26	1.6	150	5.10

\* Size produced only upon request - delivery conditions and terms to be agreed. Standard shipping lengths: 80 pitches = 10 feet = 3,048 metres.

# ACCATE C - CARBON STEEL

- Case-hardened carbon steel slats and pins.

## PRODUCT CODES

SCR 815 K325\* internal code C.7.90.040

## CHARACTERISTICS

	Slat width (mm/ ")	Hardness surf./core	GP (mm)	RCC (mm)	Weight kg/m
SCR 815 K325*	82.5 3 <sup>1</sup> / <sub>4</sub>	55/40	2.8	75	2.10

\* Size produced only upon request - delivery conditions and terms to be agreed. Standard shipping lengths: 80 pitches = 10 feet = 3,048 metres.

## REDUCED PLATE GAP (1.6)

## PRODUCT CODES

SC 815 K325\* internal code C.7.90.041  
 SC 815 K350\* internal code C.7.90.061  
 SC 815 K450\* internal code C.7.90.080

## CHARACTERISTICS

	Slat width (mm/ ")	Hardness surf./core	GP (mm)	RCC (mm)	Weight kg/m
SC 815 K325*	82.5 3 <sup>1</sup> / <sub>4</sub>	55/40	1.6	150	2.65
SC 815 K350*	88.9 3 <sup>1</sup> / <sub>2</sub>	55/40	1.6	150	2.75
SC 815 K450*	114.3 4 <sup>1</sup> / <sub>2</sub>	55/40	1.6	150	3.30



# ACCATE - CARBON STEEL

- Heat-treated carbon steel slats.
- Case-hardened carbon steel pins.

## PRODUCT CODES

SR 815 K250 internal code 7.90.020  
 SR 815 K325 internal code 7.90.040  
 SR 815 K500 internal code 7.90.090

## CHARACTERISTICS

	Slat width (mm/ ")	Hardness (HRC)	GP (mm)	RCC (mm)	Weight kg/m
SR 815 K250	63.5 2 <sup>1</sup> / <sub>2</sub>	43	2.8	75	2.20
SR 815 K325	82.5 3 <sup>1</sup> / <sub>4</sub>	43	2.8	75	2.60
SR 815 K500	127.0 5	43	2.8	75	3.50

\* Size produced only upon request - delivery conditions and terms to be agreed. Standard shipping lengths: 80 pitches = 10 feet = 3,048 metres.

## REDUCED PLATE GAP (1.6)

## PRODUCT CODES

S 815 K225 internal code 7.90.015  
 S 815 K250 internal code 7.90.021  
 S 815 K263\* internal code 7.90.025  
 S 815 K300 internal code 7.90.031  
 S 815 K325 internal code 7.90.041  
 S 815 K350 internal code 7.90.061  
 S 815 K400 internal code 7.90.070  
 S 815 K450 internal code 7.90.080  
 S 815 K473\* internal code 7.90.220  
 S 815 K600 internal code 7.90.100  
 S 815 K750 internal code 7.90.110

## CHARACTERISTICS

	Slat width (mm/ ")	Hardness (HRC)	GP (mm)	RCC (mm)	Weight kg/m
S 815 K225	57.1 2 <sup>1</sup> / <sub>4</sub>	43	1.6	150	2.18
S 815 K250	63.5 2 <sup>1</sup> / <sub>2</sub>	43	1.6	150	2.25
S 815 K263*	66.7 2 <sup>5</sup> / <sub>8</sub>	43	1.6	150	2.33
S 815 K300	76.2 3	43	1.6	150	2.35
S 815 K325	82.5 3 <sup>1</sup> / <sub>4</sub>	43	1.6	150	2.50
S 815 K350	88.9 3 <sup>1</sup> / <sub>2</sub>	43	1.6	150	2.75
S 815 K400	101.6 4	43	1.6	150	2.65
S 815 K450	114.3 4 <sup>1</sup> / <sub>2</sub>	43	1.6	150	3.00
S 815 K473*	120.0 -	43	1.6	150	3.30
S 815 K600	152.4 6	43	1.6	150	4.20
S 815 K750	190.5 7 <sup>1</sup> / <sub>2</sub>	43	1.6	150	5.10



# Mignon straight running chains - Single hinge

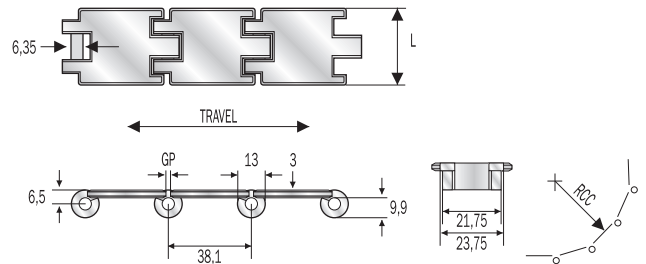
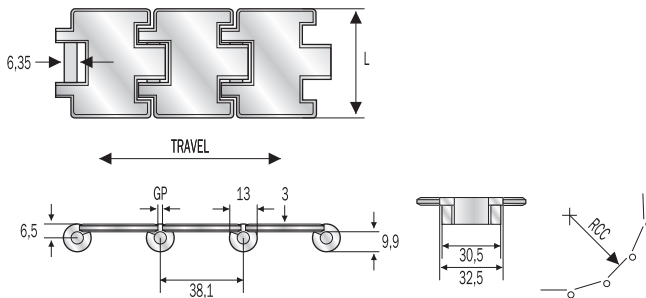
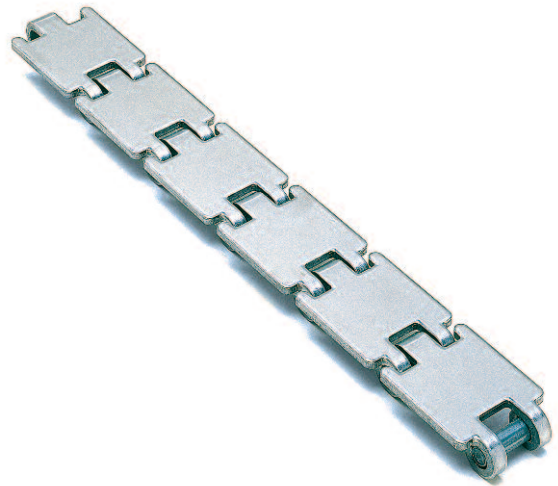
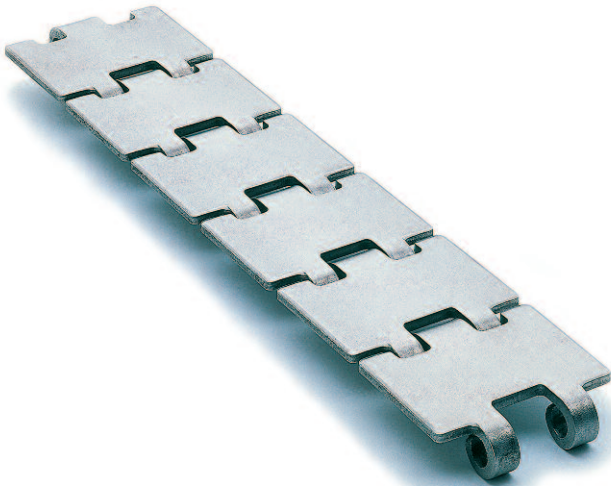

## STANDARD - INOX

- Ferritic, AISI 430 stainless steel slats, work hardened, with shiny surface having low roughness.
- AISI 431 stainless steel pins, magnetic and work hardened for high resistance.

### PRODUCT CODES

SSR 812 K197 internal code 7.00.010

### CHARACTERISTICS

	Slat width (mm/ ")	Hardness (HRC)	GP (mm)	RCC (mm)	Weight kg/m
SSR 812 K197	50.0	- 20	2.5	90	1.60

Standard shipping lengths: 80 pitches = 10 feet = 3,048 metres.

## SUPER - HARD INOX

◀ HB OR XHB PINS  
UPON REQUEST

- Special, chrome-nickel, stainless steel slats, work hardened for high resistance, with shiny surface having a roughness of  $Ra \leq 0.3$  micron.
- AISI 431 stainless steel pins, magnetic and work hardened for high resistance.

### PRODUCT CODES

SSHR 812 K125 internal code 8.25.280

SSHR 812 K175 internal code 8.25.300

### CHARACTERISTICS

	Slat width (mm/ ")	Hardness (HRC)	GP (mm)	RCC (mm)	Weight kg/m	
SSHR 812 K125	31.8	1 $\frac{1}{4}$	30	2.8	75	1.10
SSHR 812 K175	44.5	1 $\frac{3}{4}$	30	2.8	75	1.30

Standard shipping lengths: 80 pitches = 10 feet = 3,048 metres.

## STELLA D - INOX 18/8

- Chrome-nickel, austenitic AISI 304 stainless steel slats (18% Chrome - 8% Nickel), work hardened for HR - shiny - with a roughness of  $Ra < 0.5$  micron.
- Austenitic stainless steel pins (18% Chrome - 8% Nickel), work hardened for high resistance.

### PRODUCT CODES

SSAR 815 K197 internal code 7.10.010

### CHARACTERISTICS

	Slat width (mm/ ")	Hardness (HRC)	GP (mm)	RCC (mm)	Weight kg/m
SSAR 815 K197	50.0	- 26	2.5	90	1.60

Standard shipping lengths: 80 pitches = 10 feet = 3,048 metres.



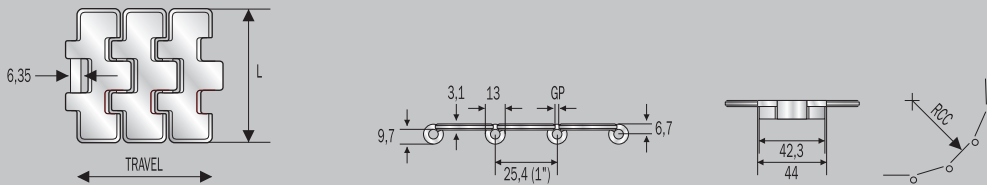

## SUPER - HARD INOX

- Special, chrome-nickel, stainless steel slats, work hardened for high resistance, with shiny surface having a roughness of  $R_a \leq 0,3$  micron.
- AISI 431 stainless steel pins, magnetic and work hardened for high resistance.

REDUCED PLATE GAP (1.6)

### PRODUCT CODES

SSH 512 K197	internal code S.9.00.010
SSH 512 K217	internal code S.9.00.017
SSH 512 K236	internal code S.9.00.036
SSH 512 K250	internal code S.9.00.020
SSH 512 K283	internal code S.9.00.283
SSH 512 K325	internal code S.9.00.040
SSH 512 K350	internal code S.9.00.060
SSH 512 K400	internal code S.9.00.070

### CHARACTERISTICS

	Slat width (mm)	Hardness (HRC)	GP (mm)	RCC (mm)	Weight kg/m
SSH 512 K197	50.0	30	1.6	100	2.20
SSH 512 K217	55.0	30	1.6	100	2.29
SSH 512 K236	60.0	30	1.6	100	2.41
SSH 512 K250	63.5	30	1.6	100	2.49
SSH 512 K283	72.0	30	1.6	100	2.65
SSH 512 K325	82.5	30	1.6	100	2.86
SSH 512 K350	88.9	30	1.6	100	3.01
SSH 512 K400	101.6	30	1.6	100	3.26

\* Standard shipping lengths: 120 pitches = 10 feet = 3,048 metres.

# Straight running chains - Single reinforced hinge

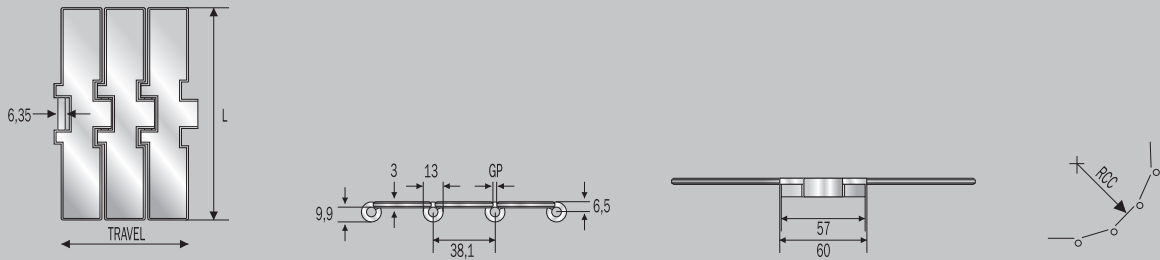
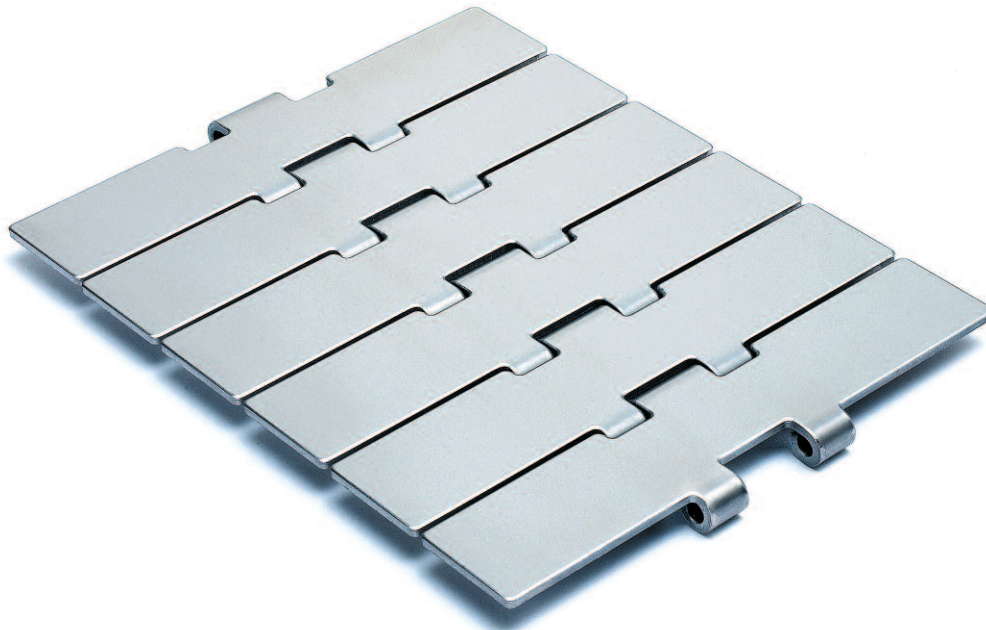

HB OR XHB PINS  
UPON REQUEST

## SUPER - HARD INOX

- Special, chrome-nickel, stainless steel slats, work hardened for high resistance, with shiny surface having a roughness of  $Ra \leq 0.3$  micron.
- AISI 431 stainless steel pins, magnetic and work hardened for high resistance.

REDUCED PLATE GAP (1.6)

### PRODUCT CODES

SSH 8127 K750

internal code S.7.00.175

### CHARACTERISTICS

	Slat width (mm/ ")	Hardness (HRC)	GP (mm)	RCC (mm)	Weight kg/m
SSH 8127 K750	190.5 7 <sup>1</sup> / <sub>2</sub>	30	1.6	150	5.10

Standard shipping lengths: 80 pitches = 10 feet = 3,048 metres.

# Straight running chains - Double hinge

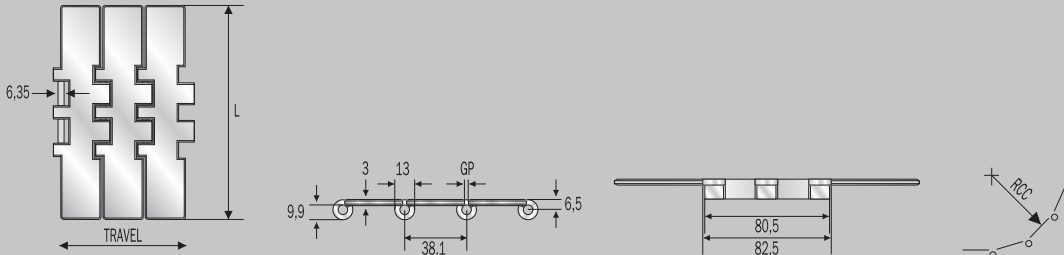
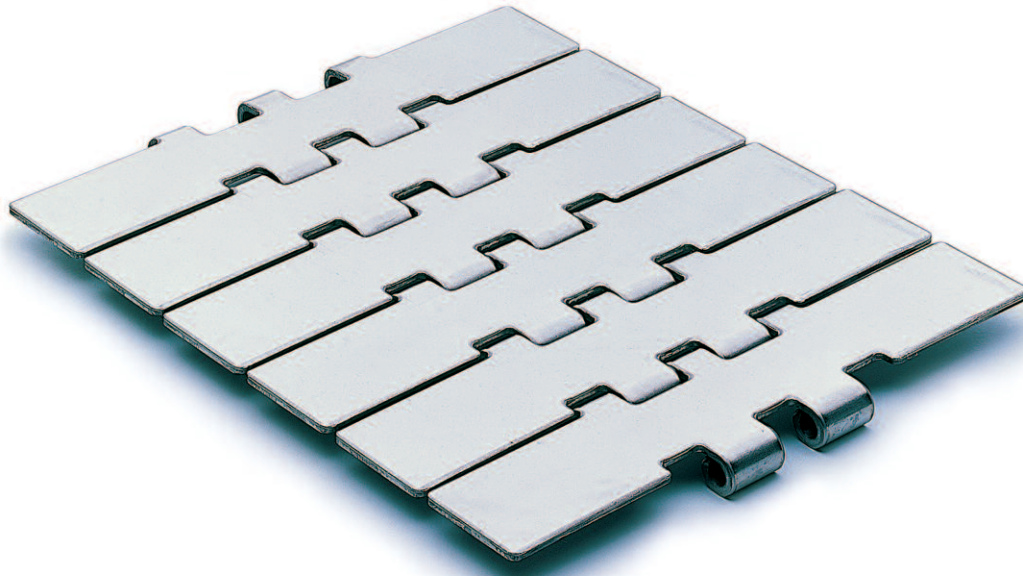

## STANDARD - INOX

- Ferritic, AISI 430 stainless steel slats, work hardened, with shiny surface having low roughness.
- AISI 431 stainless steel pins, magnetic and work hardened for high resistance.

REDUCED PLATE GAP (1.6)

### PRODUCT CODES

SS 802 K750 internal code 7.04.110

### CHARACTERISTICS

	Slat width (mm/ ")	Hardness (HRC)	GP (mm)	RCC (mm)	Weight kg/m
SS 802 K750	190.5 7 <sup>1</sup> / <sub>2</sub>	20	1.6	150	5.80

## SUPER - HARD INOX

< HB OR XHB PINS  
UPON REQUEST

- Special, chrome-nickel, stainless steel slats, work hardened for high resistance, with shiny surface having a roughness of Ra ≤ 0.3 micron.
- AISI 431 stainless steel pins, magnetic and work hardened for high resistance.

REDUCED PLATE GAP (1.6)

### PRODUCT CODES

SSH 802 K750 internal code S.7.04.110

### CHARACTERISTICS

	Slat width (mm/ ")	Hardness (HRC)	GP (mm)	RCC (mm)	Weight kg/m
SSH 802 K750	190.5 7 <sup>1</sup> / <sub>2</sub>	30	1.6	150	5.80

## STELLA D - INOX 18/8

- Chrome-nickel, austenitic AISI 304 stainless steel slats (18% Chrome - 8% Nickel), work hardened for HR - shiny - with a roughness of Ra < 0.5 micron.
- Austenitic stainless steel pins (18% Chrome - 8% Nickel), work hardened for high resistance.

REDUCED PLATE GAP (1.6)

### PRODUCT CODES

SSA 805 K750 internal code 7.14.110

### CHARACTERISTICS

	Slat width (mm/ ")	Hardness (HRC)	GP (mm)	RCC (mm)	Weight kg/m
SSA 805 K750	190.5 7 <sup>1</sup> / <sub>2</sub>	26	1.6	150	5.80

Standard shipping lengths: 80 pitches = 10 feet = 3,048 metres.

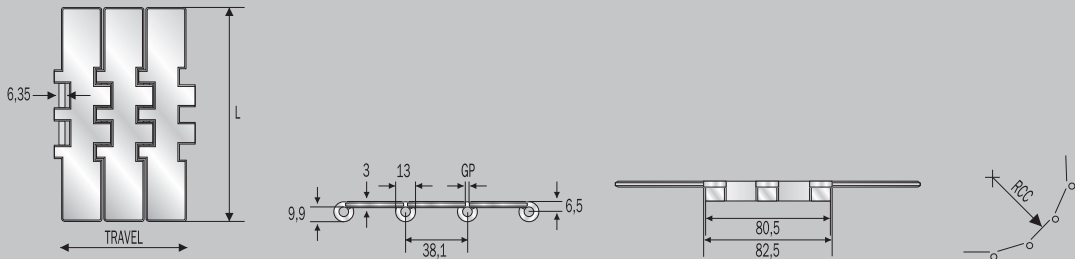
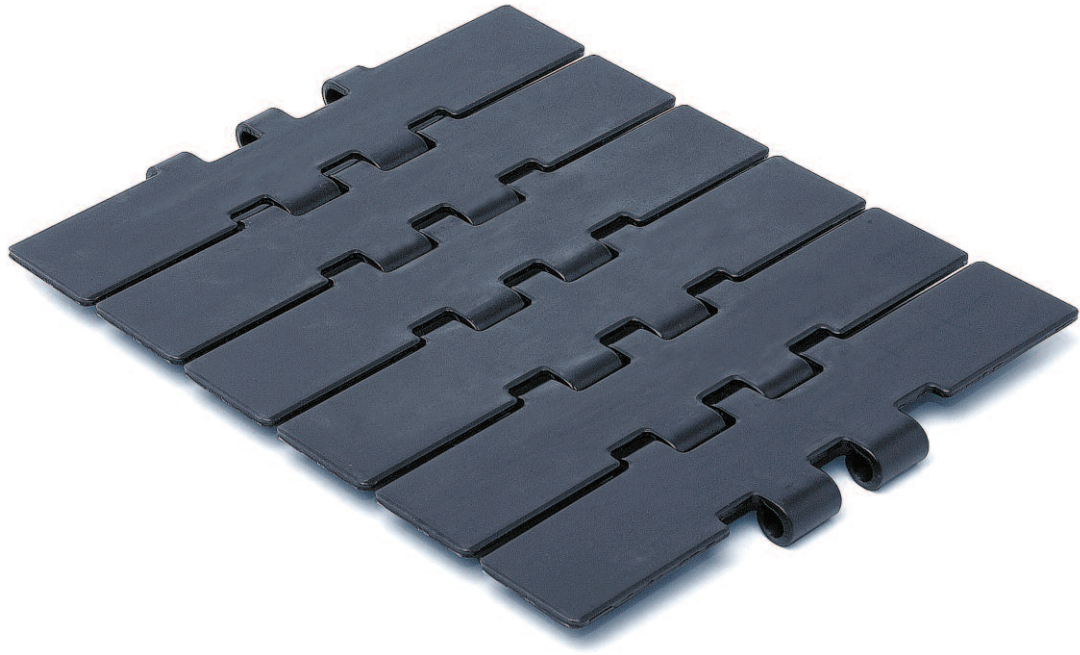

## ACCATE - CARBON STEEL

- Heat-treated carbon steel slats.
- Case-hardened carbon steel pins.

### PRODUCT CODES

SR 802 K750 internal code 7.94.111

### PRODUCT CODES

S 802 K750 internal code 7.94.110

REDUCED PLATE GAP (1.6)

### CHARACTERISTICS

	Slat width (mm/ ")	Hardness (HRC)	GP (mm)	RCC (mm)	Weight kg/m
SR 802 K750	190.5 7 <sup>1</sup> / <sub>2</sub>	43	2.8	75	5.70

Standard shipping lengths: 80 pitches = 10 feet = 3,048 metres.

### CHARACTERISTICS

	Slat width (mm/ ")	Hardness (HRC)	GP (mm)	RCC (mm)	Weight kg/m
S 802 K750	190.5 7 <sup>1</sup> / <sub>2</sub>	43	1.6	150	5.80

Standard shipping lengths: 80 pitches = 10 feet = 3,048 metres.

## Straight running chains - Double reinforced hinge

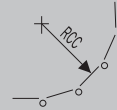
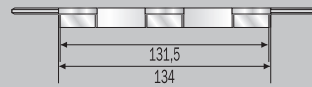
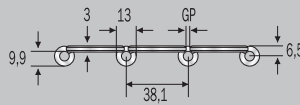
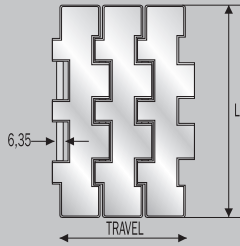
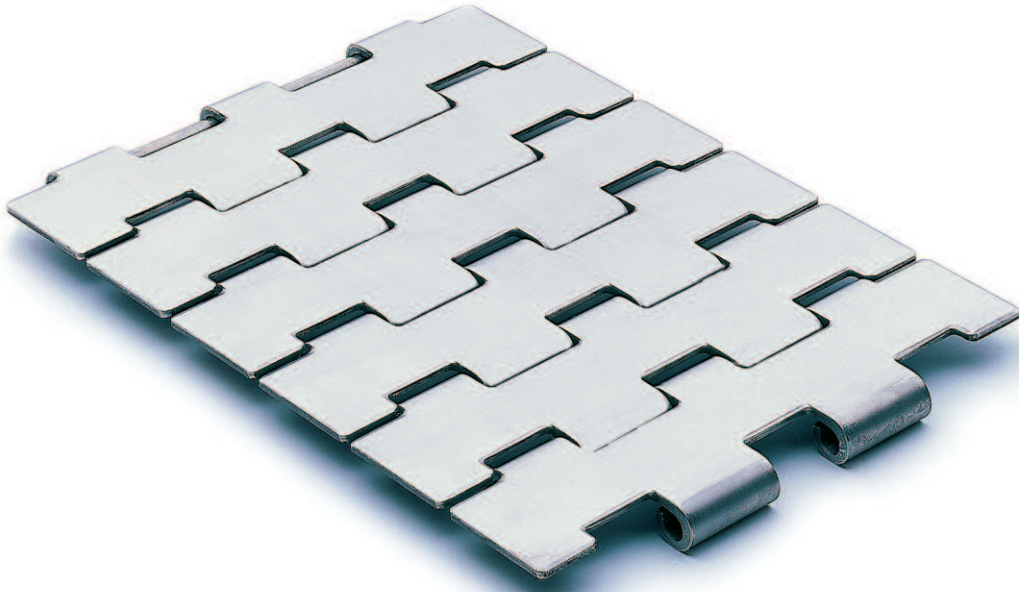

### STELLA D - INOX 18/8

- Chrome-nickel, austenitic AISI 304 stainless steel slats (18% Chrome - 8% Nickel), work hardened for high resistance - shiny - with a roughness of Ra < 0.5 micron.
- Austenitic stainless steel pins (18% Chrome - 8% Nickel), work hardened for high resistance.

#### PRODUCT CODES

SSAR 804 K670	internal code 7.24.050
SSAR 804 K750	internal code 7.24.060

#### CHARACTERISTICS

	Slat width (mm/ ")	Hardness (HRC)	GP (mm)	RCC (mm)	Weight kg/m	
SSAR 804 K670	170.0	-	26	2.5	90	6.30
SSAR 804 K750	190.5	7 <sup>1</sup> / <sub>2</sub>	26	2.5	90	6.80

Standard shipping lengths: 80 pitches = 10 feet = 3,048 metres.





## FLEX RXM - INOX 18/8

- Chrome-nickel, austenitic AISI 304 stainless steel slats (18% Chrome - 8% Nickel), work hardened for HR - shiny with a roughness of Ra < 0.5 micron.
- Chrome-nickel, austenitic stainless steel guide shoes (18% Chrome - 8% Nickel), work hardened for high resistance.
- Austenitic stainless steel pins (18% Chrome - 8% Nickel), work hardened for high resistance.

### PRODUCT CODES

SSA 881 K325	internal code 8.13.040
SSA 881 K450	internal code 8.13.080
SSA 881 K750	internal code 8.13.110
SSA 881 T K325	internal code 8.13.041
SSA 881 T K450	internal code 8.13.081
SSA 881 T K750	internal code 8.13.111

### CHARACTERISTICS

	Slat width (mm/ ")	Min. sideflexing radius (mm)	Weight kg/m
SSA 881 K325	82.5 3 <sup>1</sup> / <sub>4</sub>	457	2.90
SSA 881 K450	114.3 4 <sup>1</sup> / <sub>2</sub>	500	3.60
SSA 881 K750	190.5 7 <sup>1</sup> / <sub>2</sub>	500	5.30
SSA 881 T K325	82.5 3 <sup>1</sup> / <sub>4</sub>	457	3.10
SSA 881 T K450	114.3 4 <sup>1</sup> / <sub>2</sub>	500	3.80
SSA 881 T K750	190.5 7 <sup>1</sup> / <sub>2</sub>	500	5.50

## FLEX RXM - INOX 316

- Chrome-nickel, austenitic AISI 316L stainless steel slats (18% Chrome - 14% Nickel - 3% Molybdenum).
- Chrome-nickel, austenitic AISI 316L stainless steel guide shoes.
- Austenitic AISI 316 stainless steel pins.

### PRODUCT CODES

SSAA 881 T K325*	internal code 8.33.041
SSAA 881 T K450*	internal code 8.33.081
SSAA 881 T K750*	internal code 8.33.111

### CHARACTERISTICS

	Slat width (mm/ ")	Min. sideflexing radius (mm)	Weight kg/m
SSAA 881 T K325*	82.5 3 <sup>1</sup> / <sub>4</sub>	457	3.10
SSAA 881 T K450*	114.3 4 <sup>1</sup> / <sub>2</sub>	500	3.80
SSAA 881 T K750*	190.5 7 <sup>1</sup> / <sub>2</sub>	500	5.50

## FLEX RXMA - CARBON STEEL

- Heat-treated carbon steel slats, with a surface and core hardness of 43 HRC.
- Case-hardened carbon steel pins.

NOTE: Upon request, the "Flex RXMA Tab" chain with a slat width of 82.5 mm (3 1/4") can be produced in case-hardened carbon steel having a surface hardness of 55 HRC and a core hardness of 40 HRC (code: C.8.93.041).

### PRODUCT CODES

S 881 K325	internal code 8.93.040
S 881 K450	internal code 8.93.080
S 881 K750	internal code 8.93.110
S 881 T K250	internal code 8.93.021
S 881 T K325	internal code 8.93.041
S 881 T K450	internal code 8.93.081
S 881 T K750	internal code 8.93.111

### CHARACTERISTICS

	Slat width (mm/ ")	Min. sideflexing radius (mm)	Weight kg/m
S 881 K325	82.5 3 <sup>1</sup> / <sub>4</sub>	457	2.90
S 881 K450	114.3 4 <sup>1</sup> / <sub>2</sub>	500	3.60
S 881 K750	190.5 7 <sup>1</sup> / <sub>2</sub>	500	5.30
S 881 T K250	63.5 2 <sup>1</sup> / <sub>2</sub>	457	2.65
S 881 T K325	82.5 3 <sup>1</sup> / <sub>4</sub>	457	3.10
S 881 T K450	114.3 4 <sup>1</sup> / <sub>2</sub>	500	3.80
S 881 T K750	190.5 7 <sup>1</sup> / <sub>2</sub>	500	5.50



\* Size produced only upon request - delivery conditions and terms to be agreed. Standard shipping lengths: 80 pitches = 10 feet = 3,048 metres.

# FLEX FMC - INOX

**NEW**

- Ferritic, AISI 430 stainless steel slats, work hardened, with shiny surface having low roughness.
- Chrome-nickel, austenitic stainless steel guide shoes (18% Chrome - 8% Nickel), work hardened for high resistance.
- AISI 431 stainless steel pins, magnetic and work hardened for high resistance.

## PRODUCT CODES

SS 8811 T K325	internal code 8.26.041
SS 8811 T K330	internal code 8.26.042
SS 8811 T K450	internal code 8.26.081
SS 8811 T K750	internal code 8.26.111

## CHARACTERISTICS

	Slat width (mm/ ")	Min. sideflexing radius (mm)	Weight kg/m
SS 8811 T K325	82.5 3 <sup>1</sup> / <sub>4</sub>	500	3.10
SS 8811 T K330	83.8 3 <sup>19</sup> / <sub>64</sub>	500	3.15
SS 8811 T K450	114.3 4 <sup>1</sup> / <sub>2</sub>	610	3.80
SS 8811 T K750	190.5 7 <sup>1</sup> / <sub>2</sub>	610	5.50

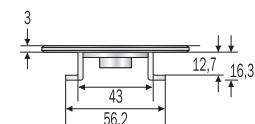
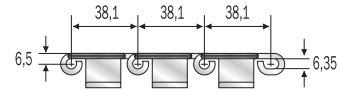
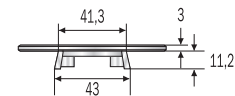
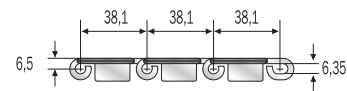
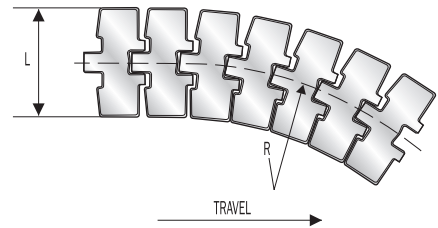

HB OR XHB PINS  
UPON REQUEST

# FLEX FMS - HARD INOX

- Special, chrome-nickel, stainless steel slats, work hardened for HR, with shiny surface having a roughness of Ra ≤ 0.3 micron.
- Chrome-nickel, austenitic stainless steel guide shoes (18% Chrome - 8% Nickel), work hardened for high resistance.
- AISI 431 stainless steel pins, magnetic and work hardened for high resistance.

## PRODUCT CODES

SSH 8811 K325	internal code S.8.26.040
SSH 8811 K350	internal code S.8.26.060
SSH 8811 K450	internal code S.8.26.080
SSH 8811 K750	internal code S.8.26.110
SSH 8811 T K325	internal code S.8.26.041
SSH 8811 T K330	internal code S.8.26.042
SSH 8811 T K350	internal code S.8.26.061
SSH 8811 T K450	internal code S.8.26.081
SSH 8811 T K750	internal code S.8.26.111

## CHARACTERISTICS

	Slat width (mm/ ")	Min. sideflexing radius (mm)	Weight kg/m
SSH 8811 K325	82.5 3 <sup>1</sup> / <sub>4</sub>	500	2.90
SSH 8811 K350	88.9 3 <sup>1</sup> / <sub>2</sub>	500	3.10
SSH 8811 K450	114.3 4 <sup>1</sup> / <sub>2</sub>	610	3.60
SSH 8811 K750	190.5 7 <sup>1</sup> / <sub>2</sub>	610	5.30
SSH 8811 T K325	82.5 3 <sup>1</sup> / <sub>4</sub>	500	3.10
SSH 8811 T K330	83.8 3 <sup>19</sup> / <sub>64</sub>	500	3.15
SSH 8811 T K350	88.9 3 <sup>1</sup> / <sub>2</sub>	500	3.30
SSH 8811 T K450	114.3 4 <sup>1</sup> / <sub>2</sub>	610	3.80
SSH 8811 T K750	190.5 7 <sup>1</sup> / <sub>2</sub>	610	5.50

XHB PINS  
UPON REQUEST

# FLEX FMD - HQ INOX

- Special, new stainless steel, chrome-nickel (W.1.4589) slats, work hardened for HR, with low surface roughness, Ra ≤ 0.2 micron.
- Chrome-nickel, austenitic stainless steel guide shoes (18% Chrome - 8% Nickel), work hardened for high resistance.
- Special martensitic stainless steel pins HB series, magnetic and heat-treated for high resistance.

## PRODUCT CODES

SSX 8811 T K325	internal code D.8.26.041
SSX 8811 T K330	internal code D.8.26.042

## CHARACTERISTICS

	Slat width (mm/ ")	Min. sideflexing radius (mm)	Weight kg/m
SSX 8811 T K325	82.5 3 <sup>1</sup> / <sub>4</sub>	500	3.10
SSX 8811 T K330	83.8 3 <sup>19</sup> / <sub>64</sub>	500	3.15

# FLEX FM - INOX 18/8

- Chrome-nickel, austenitic AISI 304 stainless steel slats (18% Chrome - 8% Nickel), work hardened for HR - shiny - with a roughness of Ra < 0.5 micron.
- Chrome-nickel, austenitic stainless steel guide shoes (18% Chrome - 8% Nickel), work hardened for high resistance.
- Austenitic stainless steel pins (18% Chrome - 8% Nickel), work hardened for high resistance.

## PRODUCT CODES

SSA 8811 K325	internal code 8.16.040
SSA 8811 K350	internal code 8.16.060
SSA 8811 T K325	internal code 8.16.041
SSA 8811 T K350	internal code 8.16.061

## CHARACTERISTICS

	Slat width (mm/ ")	Min. sideflexing radius (mm)	Weight kg/m
SSA 8811 K325	82.5 3 <sup>1</sup> / <sub>4</sub>	500	2.90
SSA 8811 K350	88.9 3 <sup>1</sup> / <sub>2</sub>	500	3.10
SSA 8811 T K325	82.5 3 <sup>1</sup> / <sub>4</sub>	500	3.10
SSA 8811 T K350	88.9 3 <sup>1</sup> / <sub>2</sub>	500	3.30

Standard shipping lengths: 80 pitches = 10 feet = 3,048 metres.



# FLEX FMS2 - R = 190mm HARD INOX

◀ HB OR XHB PINS  
UPON REQUEST

- Special, chrome-nickel, stainless steel slats, work hardened for high resistance, with shiny surface having a roughness of  $Ra \leq 0.3$  micron.
- Chrome-nickel, austenitic stainless steel guide shoes (18% Chrome - 8% Nickel), work hardened for high resistance.
- AISI 431 stainless steel pins, magnetic and work hardened for high resistance.

## PRODUCT CODES

SSH 8811 R T K325 internal code S.8.29.041

## CHARACTERISTICS

	Slat width (mm/ ")	Min. sideflexing radius (mm)	Weight kg/m
SSH 8811 R T K325	82.5 3 <sup>1</sup> / <sub>4</sub>	190	3.00

# FLEX FM2 - R = 190mm INOX 18/8

- Chrome-nickel, austenitic AISI 304 stainless steel slats (18% Chrome - 8% Nickel), work hardened for high resistance - shiny - with a roughness of  $Ra < 0.5$  micron.
- Chrome-nickel, austenitic stainless steel guide shoes (18% Chrome - 8% Nickel), work hardened for high resistance.
- Austenitic stainless steel pins (18% Chrome - 8% Nickel), work hardened for high resistance.

## PRODUCT CODES

SSA 8811 R T K325 internal code 8.19.041

## CHARACTERISTICS

	Slat width (mm/ ")	Min. sideflexing radius (mm)	Weight kg/m
SSA 8811 R T K325	82.5 3 <sup>1</sup> / <sub>4</sub>	190	3.00



# FLEX FMA2 - R = 190mm CARBON STEEL

- Heat-treated carbon steel slats, with a surface and core hardness of 43 HRC.
- Case-hardened carbon steel pins.

## PRODUCT CODES

S 8811 R T K325 internal code 8.99.041

## CHARACTERISTICS

	Slat width (mm/ ")	Min. sideflexing radius (mm)	Weight kg/m
S 8811 R T K325	82.5 3 <sup>1</sup> / <sub>4</sub>	190	3.00

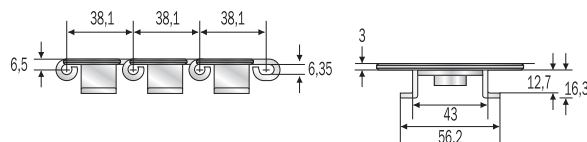
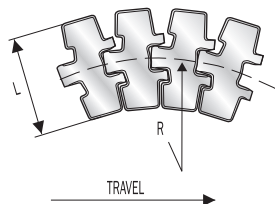
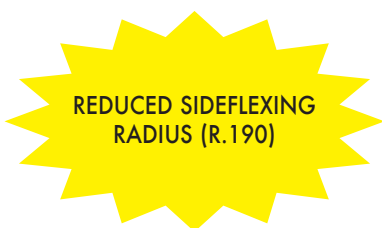
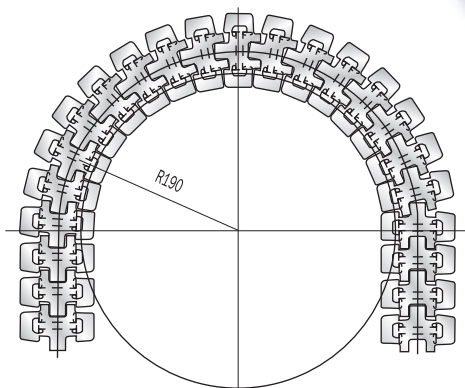

Standard shipping lengths: 80 pitches = 10 feet = 3,048 metres.  
Not to be used with a lateral curving discs.

# Sideflexing hinged slat chains for magnetic systems

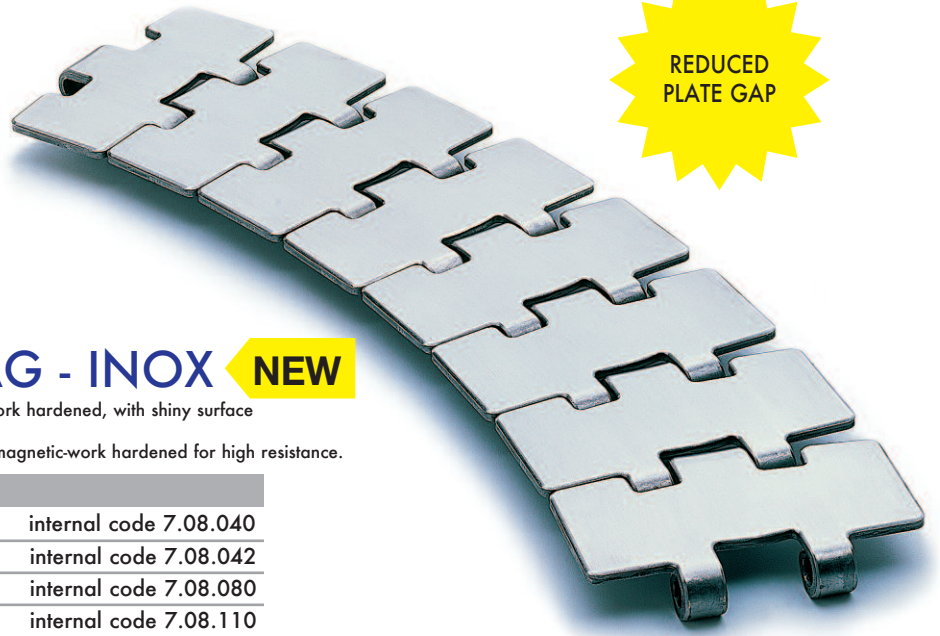

## NEW FLEX MAG - INOX **NEW**

- Ferritic, AISI 430 stainless steel slats, work hardened, with shiny surface having low roughness.
- Special, stainless steel pins, 400 series-magnetic-work hardened for high resistance.

### PRODUCT CODES

SS 8811 M K325	internal code 7.08.040
SS 8811 M K330	internal code 7.08.042
SS 8811 M K450	internal code 7.08.080
SS 8811 M K750	internal code 7.08.110

### CHARACTERISTICS

	Slat width (mm/ ")	Min. sideflexing radius (mm)	Weight kg/m
SS 8811 M K325	82.5 3 <sup>1</sup> / <sub>4</sub>	500	2.50
SS 8811 M K330	83.8 3 <sup>19</sup> / <sub>64</sub>	500	2.65
SS 8811 M K450	114.3 4 <sup>1</sup> / <sub>2</sub>	500	3.20
SS 8811 M K750	190.5 7 <sup>1</sup> / <sub>2</sub>	500	4.90

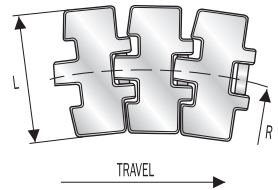

HB OR XHB PINS  
UPON REQUEST

## NEW FLEX MAG - HARD INOX

- Special, chrome-nickel, stainless steel slats, work hardened for high resistance, with shiny surface having a roughness of Ra ≤ 0.3 micron.
- Special, stainless steel pins, 400 series - magnetic - work hardened for high resistance.

### PRODUCT CODES

SSH 8811 M K325	internal code S.7.08.040
SSH 8811 M K330	internal code S.7.08.042
SSH 8811 M K450	internal code S.7.08.080
SSH 8811 M K750	internal code S.7.08.110

### CHARACTERISTICS

	Slat width (mm/ ")	Min. sideflexing radius (mm)	Weight kg/m
SSH 8811 M K325	82.5 3 <sup>1</sup> / <sub>4</sub>	500	2.50
SSH 8811 M K330	83.8 3 <sup>19</sup> / <sub>64</sub>	500	2.65
SSH 8811 M K450	114.3 4 <sup>1</sup> / <sub>2</sub>	500	3.20
SSH 8811 M K750	190.5 7 <sup>1</sup> / <sub>2</sub>	500	4.90

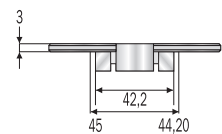
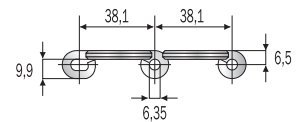

XHB PINS  
UPON REQUEST

## NEW FLEX MAG D - HQ INOX

- Special, new stainless steel, chrome-nickel (W.1.4589) slats - magnetic - work hardened for HR, with shiny surface having a roughness of Ra ≤ 0.2 micron.
- Special, martensitic stainless steel pins HB series, magnetic and heat-treated for high resistance.

### PRODUCT CODES

SSX 8811 M K325	internal code D.7.08.040
SSX 8811 M K330	internal code D.7.08.042

### CHARACTERISTICS

	Slat width (mm/ ")	Min. sideflexing radius (mm)	Weight kg/m
SSX 8811 M K325	82.5 3 <sup>1</sup> / <sub>4</sub>	500	2.50
SSX 8811 M K330	83.8 3 <sup>19</sup> / <sub>64</sub>	500	2.65

Standard shipping lengths: 80 pitches = 10 feet = 3,048 metres.

# Sideflexing chains for magnetic systems - Reinforced hinge

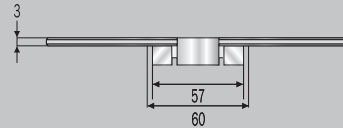
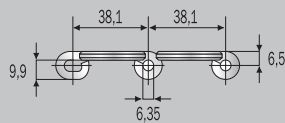
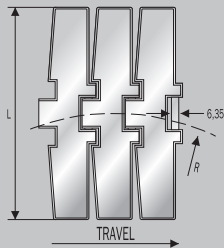
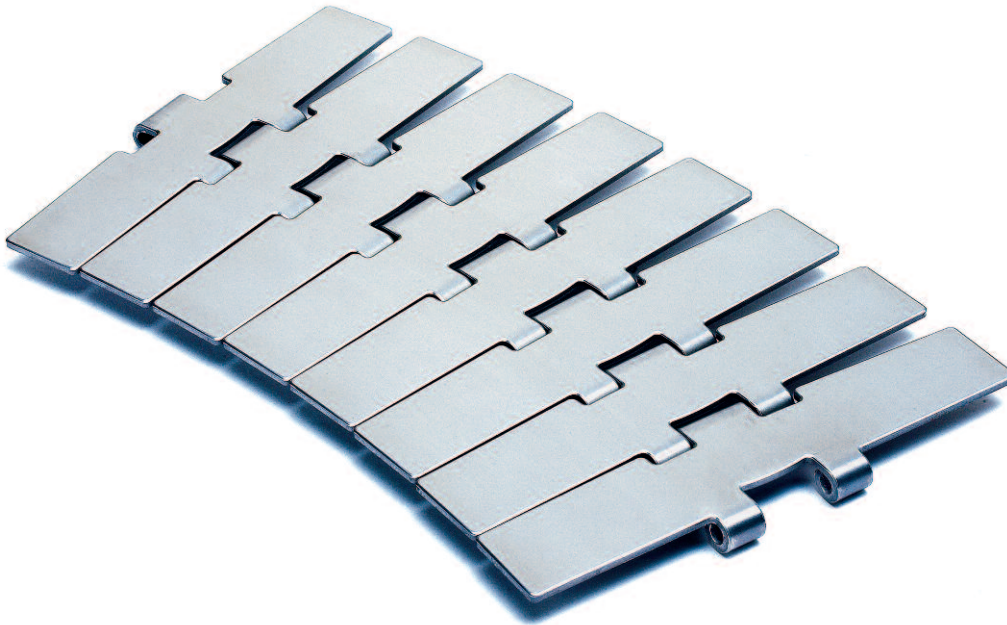

## NEW FLEX MAG - HARD INOX < HB OR XHB PINS UPON REQUEST

- Special, chrome-nickel, stainless steel slats, work hardened for high resistance, with shiny surface having a roughness of  $R_a \leq 0.3$  micron.
- Special, stainless steel pins, 400 series - magnetic - work hardened for high resistance.

### PRODUCT CODES

SSH 8817 M K750

internal code S.7.08.175

### CHARACTERISTICS

	Slat width (mm/ ")	Min. sideflexing radius (mm)	Weight kg/m
SSH 8817 M K750	190.5 7 1/2	750	5.03

Standard shipping lengths: 80 pitches = 10 feet = 3,048 metres.

# Straight running chains with rubber inserts for inclined conveyors

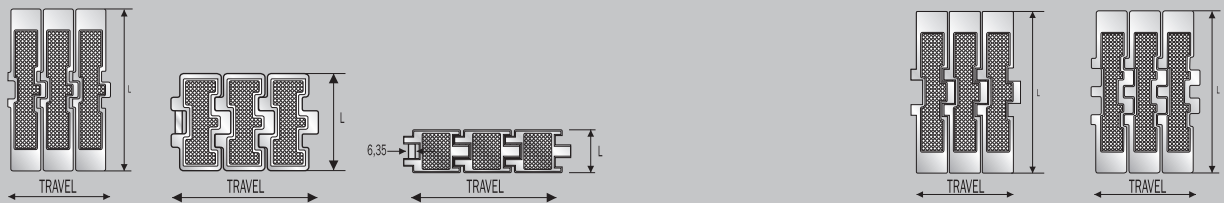
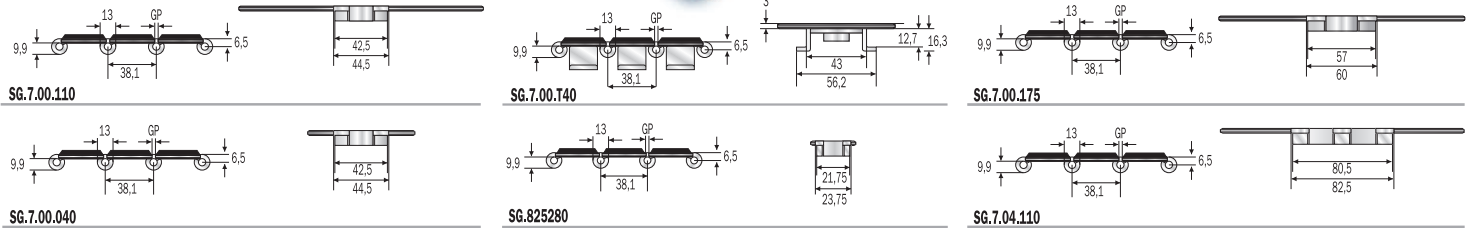
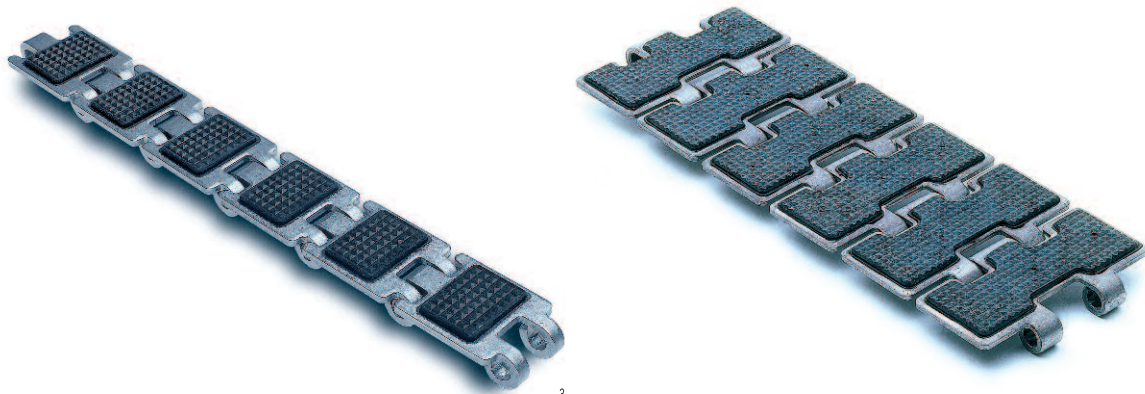

## SUPER G / DHG - HARD INOX < HB OR XHB PINS UPON REQUEST

- Special, chrome-nickel, stainless steel slats, work hardened for high resistance, with a rubber insert.
- Chrome-nickel, austenitic stainless steel guide shoes (18% Chrome - 8% Nickel), (Super-G TAB).
- AISI 431 stainless steel pins, magnetic and work hardened for high resistance.

PRODUCT CODES						
SSHR 812 G K125						internal code SG.8.25.280
SSHR 812 G K325						internal code SG.7.00.040
SSHR 812 T G K325						internal code SG.7.00.T40

CHARACTERISTICS						
	Slat width (mm/ ")	Hardness (HRC)	GP (mm)	RCC (mm)	Weight (kg/m)	
SSHR 812 G K125	31.8	1 1/4	30	2.8	75	1.20
SSHR 812 G K325	82.5	3 1/4	30	2.8	75	2.80
SSHR 812 T G K325	82.5	3 1/4	30	2.8	75	3.40

REDUCED PLATE GAP (1.6)

PRODUCT CODES	
SSH 8127 G K750	internal code SG.7.00.175

CHARACTERISTICS						
	Slat width (mm/ ")	Hardness (HRC)	GP (mm)	RCC (mm)	Weight (kg/m)	
SSH 8127 G K750	190.5	7 1/2	30	1.6	150	5.35

PRODUCT CODES						
SSH 812 G K450						internal code SG.7.00.080
SSH 812 G K600						internal code SG.7.00.100
SSH 812 G K750						internal code SG.7.00.110

CHARACTERISTICS						
	Slat width (mm/ ")	Hardness (HRC)	GP (mm)	RCC (mm)	Weight (kg/m)	
SSH 812 G K450	114.3	4 1/2	30	1.6	150	3.50
SSH 812 G K600	152.4	6	30	1.6	150	4.40
SSH 812 G K750	190.5	7 1/2	30	1.6	150	5.30

REDUCED PLATE GAP (1.6)

PRODUCT CODES	
SSH 802 G K750	internal code SG.7.04.110

CHARACTERISTICS						
	Slat width (mm/ ")	Hardness (HRC)	GP (mm)	RCC (mm)	Weight (kg/m)	
SSH 802 G K750	190.5	7 1/2	30	1.6	150	6.20

Standard shipping lengths: 80 pitches = 10 feet = 3,048 metres.



# Sideflexing hinged slat chains with rubber inserts for inclined conveyors

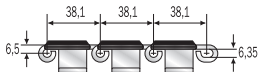
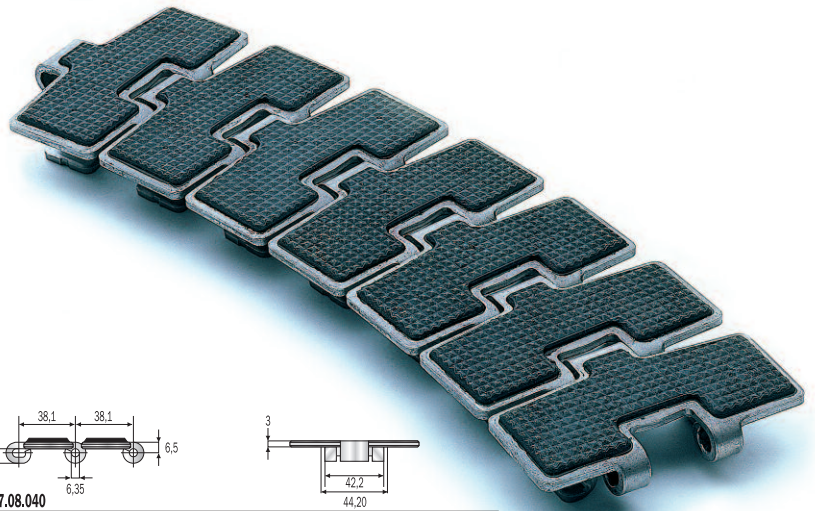

SG.8.23.041

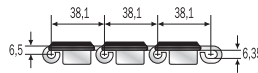

SG.8.23.040

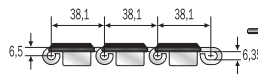

SG.8.23.110

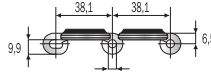

SG.7.08.040

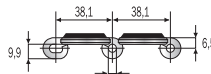

SG.7.08.175

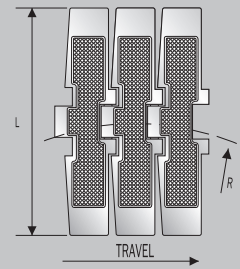
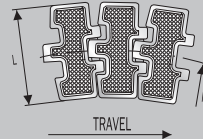
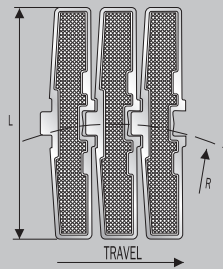
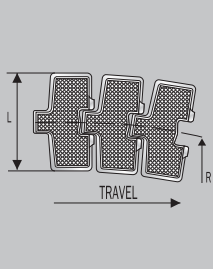

## FLEX RXMS G / NEW FLEX G MAG - HARD INOX

◀ HB OR XHB PINS UPON REQUEST

- Special, chrome-nickel, stainless steel slats, work hardened for high resistance, with a rubber insert.
- Chrome-nickel, austenitic stainless steel guide shoes (18% Chrome - 8% Nickel), (Flex RXMS - G).
- Special, stainless steel pins, 400 series - magnetic - work hardened for high resistance.

### PRODUCT CODES

SSH 881 G K325	internal code SG.8.23.040
SSH 881 G K450	internal code SG.8.23.080
SSH 881 G K750	internal code SG.8.23.110
SSH 881 T G K325	internal code SG.8.23.041
SSH 881 T G K450	internal code SG.8.23.081
SSH 881 T G K750	internal code SG.8.23.111

### CHARACTERISTICS

	Slat width (mm/ ")	Min. sideflexing radius (mm)	Weight (kg/m)
SSH 881 G K325	82.5 3 1/4	457	3.10
SSH 881 G K450	114.3 4 1/2	500	3.80
SSH 881 G K750	190.5 7 1/2	500	5.50
SSH 881 T G K325	82.5 3 1/4	457	3.30
SSH 881 T G K450	114.3 4 1/2	500	4.00
SSH 881 T G K750	190.5 7 1/2	500	5.70

### PRODUCT CODES

SSH 881 M G K325	internal code SG.7.08.040
SSH 881 M G K750	internal code SG.7.08.110

### CHARACTERISTICS

	Slat width (mm/ ")	Min. sideflexing radius (mm)	Weight (kg/m)
SSH 881 M G K325	82.5 3 1/4	500	2.70
SSH 881 M G K750	190.5 7 1/2	500	5.10

### PRODUCT CODES

SSH 8817 M G K750	internal code SG.708175
-------------------	-------------------------

### CHARACTERISTICS

	Slat width (mm/ ")	Min. sideflexing radius (mm)	Weight (kg/m)
SSH 8817 M G K750	190.5 7 1/2	750	5.14

Standard shipping lengths: 80 pitches = 10 feet = 3,048 metres.

## Block body machined steel sprockets

### FOR STRAIGHT RUNNING CHAINS AND FOR NEW FLEX MAG/ NEW FLEX MAG D/NEW FLEX MAG G CHAINS

The sprocket tooth pitch (mm 19,05) is half the pitch of the chain (38,1 mm). Therefore, when a sprocket with an odd number of teeth is used, the teeth engage the chain only every other revolution. This doubles the life of sprockets.

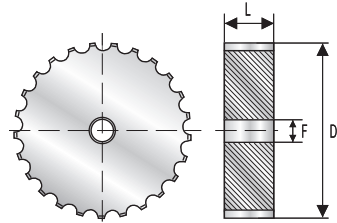

#### CODES / CHARACTERISTICS

	Width (mm)	Number of teeth (z)	DE outside diameter (mm)	Pitch diameter (mm)	F plain bore diameter (mm)	Weight kg/unit
8.12.005	43.50	15	92.90	93.70	20.0	1.86
8.12.010	43.50	17	104.70	105.47	20.0	2.34
8.12.020	43.50	19	117.10	117.35	20.0	3.05
8.12.030	43.50	21	130.05	129.25	20.0	3.80
8.12.040	43.50	23	142.00	141.20	20.0	4.60
8.12.050	43.50	25	154.20	153.20	20.0	5.40
8.12.060	43.50	27	166.60	165.20	20.0	6.40
8.12.070	43.50	29	179.05	177.25	20.0	7.50
8.12.080	43.50	31	191.25	189.30	20.0	8.70

### FOR MIGNON /FLEX RXMC/FLEX RXMS/FLEX RXM/FLEX RXM 316/ FLEX RXMA/FLEX FMC/FLEX FMS/FLEX FMD/FLEX FM/FLEX FMS2/ FLEX FM2/FLEX FMA2/FLEX RXMS G/SUPER G TAB CHAINS

The sprocket tooth pitch (mm 19,05) is half the pitch of the chain (38,1 mm). Therefore, when a sprocket with an odd number of teeth is used, the teeth engage the chain only every other revolution. This doubles the life of sprockets.

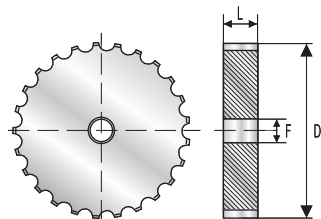

#### CODES / CHARACTERISTICS

	Width (mm)	Number of teeth (z)	DE outside diameter (mm)	Pitch diameter (mm)	F plain bore diameter (mm)	Weight kg/unit
8.12.120	31.0	19	117.10	117.35	20.0	2.20
8.12.130	31.0	21	130.05	129.25	20.0	2.70
8.12.140	31.0	23	142.00	141.20	20.0	3.30
8.12.150	31.0	25	154.20	153.20	20.0	3.90
8.12.160	31.0	27	166.60	165.20	20.0	4.60

# 1864 Straight running plate top chains

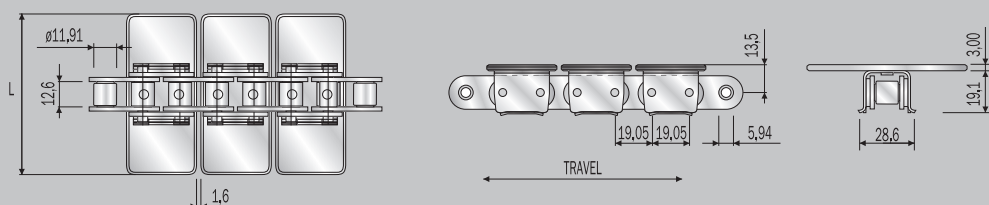

## 1864

This high speed, high capacity series offers better efficiency and reliability in applications where high temperatures or abrasive materials are involved.

- Steel and stainless steel top plates.
- Base roller chain, 19,05 mm - 3/4" pitch ANSI 60.

### PRODUCT CODES

1864 K325	internal code 1864.CC.041
1864 K450	internal code 1864.CC.081
1864 K600	internal code 1864.CC.101
1864 K750	internal code 1864.CC.111

### CHARACTERISTICS

	Slat width (mm)	Ultimate strength (N)	Weight kg/m
1864 K325	82.5	37000	3.33
1864 K450	114.3	37000	4.00
1864 K600	152.4	37000	5.33
1864 K750	190.5	37000	5.68

### PRODUCT CODES

1864 A K325	internal code 1864.CS.041
1864 A K450	internal code 1864.CS.081
1864 A K600	internal code 1864.CS.101
1864 A K750	internal code 1864.CS.111

### CHARACTERISTICS

	Slat width (mm)	Ultimate strength (N)	Weight kg/m
1864 A K325	82.5	37000	3.33
1864 A K450	114.3	37000	4.00
1864 A K600	152.4	37000	5.33
1864 A K750	190.5	37000	5.68

### PRODUCT CODES

1864 SS K325	internal code 1864.SS.041
1864 SS K450	internal code 1864.SS.081
1864 SS K600	internal code 1864.SS.101
1864 SS K750	internal code 1864.SS.111

### CHARACTERISTICS

	Slat width (mm)	Ultimate strength (N)	Weight kg/m
1864 SS K325	82.5	26000	3.33
1864 SS K450	114.3	26000	4.00
1864 SS K600	152.4	26000	5.33
1864 SS K750	190.5	26000	5.68

### NOTE ON MATERIALS

- 1864 - steel base roller chain, steel top plate.
- 1864 A - steel base roller chain, stainless steel top plate.
- 1864 SS - stainless steel base roller chain, stainless steel top plate.

# 1874 Sideflexing plate top chains

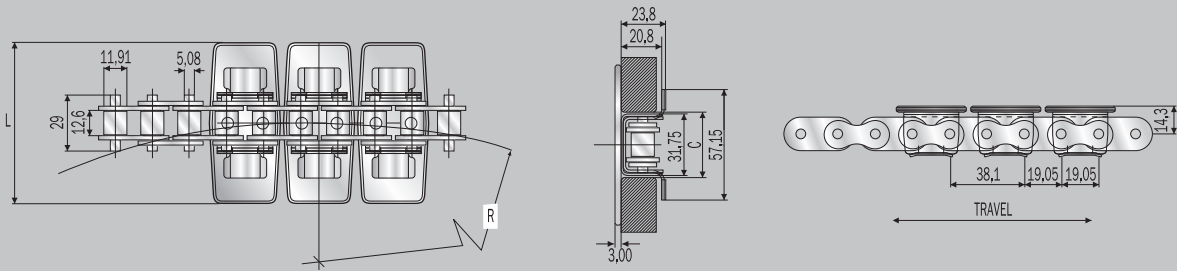

## 1874

This high speed, high capacity series offers better efficiency and reliability in applications where high temperatures or abrasive materials are involved.

- Steel and stainless steel top plates.
- Base roller chain, 19,05 mm - 3/4" pitch ANSI 63 SB.

### PRODUCT CODES

1874 K325	internal code 1874.CC.041
1874 K450	internal code 1874.CC.081
1874 K600	internal code 1874.CC.101
1874 K750	internal code 1874.CC.111

### CHARACTERISTICS

	Slat width (mm)	Ultim. str. (N)	Straight C (mm)	Curve C (mm)	R (mm)	Weight (kg/m)
1874 K325	82.5	27000	34.1	34.6	356	4.20
1874 K450	114.3	27000	34.1	34.6	356	4.80
1874 K600	152.4	27000	34.1	34.6	457	5.70
1874 K750	190.5	27000	34.1	34.6	610	6.40

### PRODUCT CODES

1874 A K325	internal code 1874.CS.041
1874 A K450	internal code 1874.CS.081
1874 A K600	internal code 1874.CS.101
1874 A K750	internal code 1874.CS.111

### CHARACTERISTICS

	Slat width (mm)	Ultim. str. (N)	Straight C (mm)	Curve C (mm)	R (mm)	Weight (kg/m)
1874 A K325	82.5	27000	34.1	34.6	356	4.20
1874 A K450	114.3	27000	34.1	34.6	356	4.80
1874 A K600	152.4	27000	34.1	34.6	457	5.70
1874 A K750	190.5	27000	34.1	34.6	610	6.40

### PRODUCT CODES

1874 SS K325	internal code 1874.SS.041
1874 SS K450	internal code 1874.SS.081
1874 SS K600	internal code 1874.SS.101
1874 SS K750	internal code 1874.SS.111

### CHARACTERISTICS

	Slat width (mm)	Ultim. str. (N)	Straight C (mm)	Curve C (mm)	R (mm)	Weight (kg/m)
1874 SS K325	82.5	21000	34.1	34.6	356	4.20
1874 SS K450	114.3	21000	34.1	34.6	356	4.80
1874 SS K600	152.4	21000	34.1	34.6	457	5.70
1874 SS K750	190.5	21000	34.1	34.6	610	6.40

### NOTE ON MATERIALS

- 1874 - steel base roller chain, steel top plate.  
 1874 A - steel base roller chain, stainless steel top plate.  
 1874 SS - stainless steel base roller chain, stainless steel top plate.

Standard shipping lengths: 160 pitches = 10 feet = 3,048 metres.



# Steel corrosion resistance table

## Legend

- = Little resistance - not recommended
- = Average resistance
- = Good resistance - it can be used

CHEMICAL AGENT	FERRITIC STAINLESS STEEL	SPECIAL Cr-Ni STAINLESS STEEL	SPECIAL NEW Cr-Ni STAINLESS STEEL	AUSTENITIC STAINLESS STEEL	AUSTENITIC STAINLESS STEEL	CARBON STEEL
	INOX	HARD INOX	HQ INOX	INOX 18/8	INOX 316	
A Acetic acid	○	○	○	•	••	○
Acetone	••	••	••	••	••	○
Aluminium chloride	○	○	○	•	•	○
Ammonia	••	••	••	••	••	○
Ammonium chloride	○	○	○	•	•	○
Amyl alcohol	○	•	•	••	••	○
Aniline	•	•	•	•	•	○
Animal oil	••	••	••	••	••	••
B Beer	••	••	••	••	••	•
Benzene	○	•	•	••	••	○
Benzoic acid	○	○	○	•	•	○
Benzol	•	•	•	••	••	•
Boric acid	○	•	•	•	•	○
Brine	○	○	○	•	••	○
Butter	○	•	•	••	••	○
Butyl alcohol	○	•	•	••	••	○
Butyric acid	○	○	○	•	•	○
C Calcium chloride	○	○	○	○	•	○
Carbon disulphide	•	•	•	••	••	○
Carbon tetrachloride	•	•	•	••	••	•
Carbonated drinks	••	••	••	••	••	○
Caustic soda (20%)	••	••	••	••	••	○
Chlorine water	○	○	○	○	○	○
Chloroform	○	•	•	••	••	○
Citric acid	•	•	•	••	••	○
Copper sulphate	•	•	•	••	••	○
D Diet oil	••	••	••	••	••	•
Diet fat	••	••	••	••	••	○
Diluted acetic acid	○	○	○	•	••	○
Distilled water	••	••	••	••	••	○
E Ethyl acetate	○	○	○	•	•	○
Ethyl alcohol	○	•	•	••	••	○
Ethyl chloride	•	••	••	••	••	○
F Flax oil	•	•	•	••	••	•
Formaldehyde	○	•	•	••	••	○
Formic acid	○	○	○	○	○	○
Freon 12	○	○	○	••	••	○
Fresh water	••	••	••	••	••	○
Fruit juice	•	•	•	••	••	○
G Gasoline	•	•	•	••	••	•
Glycerine	•	•	•	••	••	○
H Hydrochloric acid	○	○	○	○	○	○
Hydrofluoric acid	○	○	○	○	○	○
Hydrogen peroxide	○	•	•	••	••	○
I Iodine	○	○	○	○	○	○
Iron chloride	○	○	○	•	•	○
L Lactic acid	○	○	○	••	••	○
M Magnesium chloride	○	○	○	•	•	○
Mercury	○	•	•	•	•	○
Methyl alcohol	○	•	•	•	••	○
Methylene chloride	○	○	•	•	•	○
Milk	••	••	••	••	••	•
N Nitric acid	•	•	•	••	••	○
O Oil	••	••	••	••	••	••
Oil ether	○	•	•	••	••	○
Oleic acid	•	•	•	•	•	○
P Paraffin	••	••	••	••	••	••
Phenol	○	○	○	••	••	○
Phosphoric acid	•	•	•	••	••	○
Potassium hydroxine	○	○	○	•	••	○
S Sea water	○	○	○	••	••	○
Silver nitrate	○	○	○	•	•	○
Soapy water	••	••	••	••	••	○
Sodium carbonate	•	•	•	••	••	○
Sodium chloride	○	○	○	•	•	○
Sodium hydroxine	○	○	○	•	•	○
Sodium hypochlorite	○	○	○	○	○	○
Sodium silicate	○	○	○	••	••	○
Sodium sulphate	•	•	•	••	••	○
Soft drinks	••	••	••	••	••	○
Sulphuric acid	○	○	○	○	•	○
T Tartaric acid	○	○	•	•	•	○
Trichlorethylene	•	•	•	••	••	•
Turpentine	••	••	••	••	••	○
V Vegetable juice	•	•	•	••	••	○
Vegetable oil	••	••	••	••	••	••
Vinegar	○	○	•	••	••	○
W Whiskey	•	•	•	••	••	○
Wine	•	•	•	••	••	○
X Xilol	••	••	••	••	••	•
Z Zinc chloride	○	○	○	•	•	○

The indicated data are approximate as the corrosion resistance of the above-mentioned steels, according to the conditions of use, is related to the work temperature, the concentration of the chemical agent, the duration of the contact with it, etc.



**CONST****R****UKTOR**<sup>TM</sup>

www.construktor.com

info@onstruktor.com

**Poznań**

tel. +48 61 653 25 60

tel. +48 61 653 25 61

poznan@onstruktor.com

**Wrocław**

tel.+ 48 71 799 88 69

tel. +48 71 788 88 79

wroclaw@onstruktor.com

